

featuring our Portals Service Menu
and our unique

Find-It-In-Front: Dr. Pinball Section



NO YES END PREV QUIT

SEGA™ PINBALL, INC.



**TO DISABLE GRAPHIC ADULT ORIENTED SPEECH SET
ADJUSTMENT 56 (ADULT SPEECH ENABLED) TO "NO".**

REFER TO SECTION 3, CHAPTER 1, PORTALS SERVICE MENU INTRODUCTION FOR HELP.

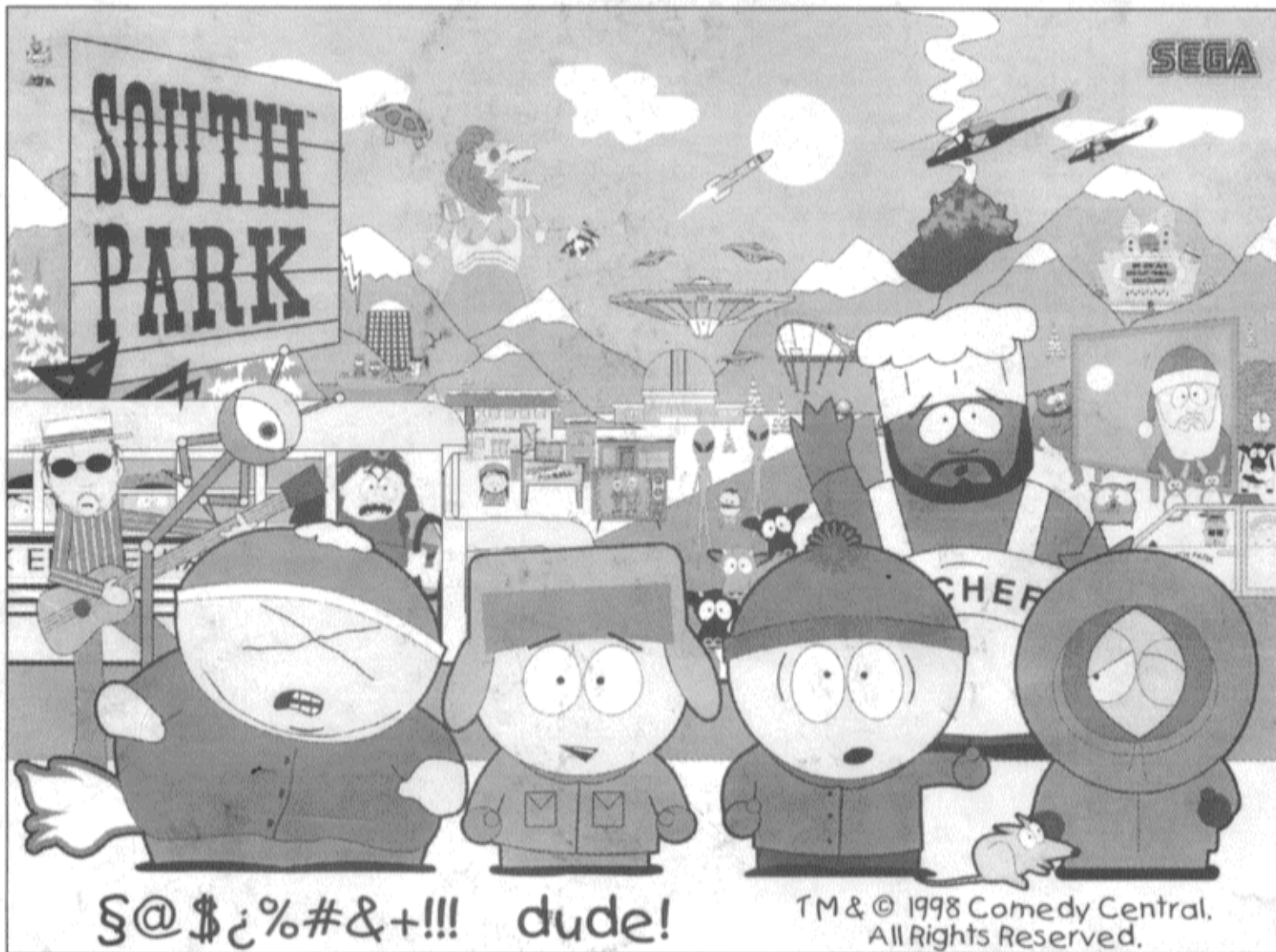

§@\$\$%#&+!!! dude!

TM & © 1998 Comedy Central.
All Rights Reserved.

Joe Blackwell
DIRECTOR,
Parts Sales &
Technical Support



Susan Molitor
Parts
Sales
MANAGER



Patty Schraps
Parts
Stockroom
MANAGER



Doug Lemons
Technical
Support
ENGINEER



Linda Garza
Customer
Service
REPRESENTATIVE



Jay Alfer
Technical Support
Documentation
ADMINISTRATOR



Sega Pinball, Inc. TM & © 1999.
All Rights Reserved. Printed in the U.S.A.

**Please call us at 1-800-542-5377 or
1-708-345-7700 for Technical Support.**

March 1999 - Print Copy

③
SPI PN#: 780-5071-00

WOW! Look what's new at Sega Pinball!



THE BACK BOX: First introduced in *Lost In Space™* Pinball is the **Sega Showcase II Backbox!** An innovative and **bold look!** A Backbox using a single lock and an **easy-to-remove** Back Glass & Speaker Panel / Dot Matrix Display. The operating principles are: it still folds down (using the original allen wrench key) and lays upon the cabinet side armor molding. And, you can service the PCBs from either side of the game. Back Glass and Speaker Panel / Dot Matrix Display cleaning and removal is easier. The reviews have been great, just look at your own game! For more on Backbox Parts, see **Section 4, Chapter 1, Parts Identificaiton (The Pink Pages)**.



MODULAR STAND-UP TARGETS:

See **Appendix I** in this manual (at the back). You can now buy just the Target Insert instead of the entire Target Assembly (if just the Target Insert is broke). Target Assemblies which are "Rear Mounted" (reversed) would use the same SPI Part N^o but add an "R" to the end.

When you order the Target Insert(s) from your distributor, it should come with an *Assembly / Disassembly Instruction Sheet*. If it does not, ask your distributor for a copy of **Sega Pinball, Inc. Service Bulletin N^o 110** (or call Technical Support at below numbers). You can also use *Service Bulletin N^o 110* to reverse the Target Insert installation if you have spare "regular" mounted targets (the Switch Actuator would need to be reversed as well). **Appendix I** will give details on the Part N^os & the Colors the targets are available in.

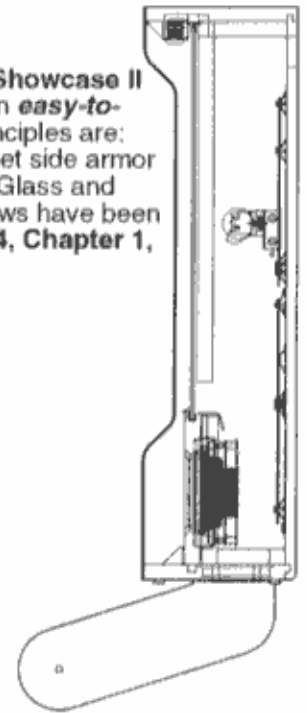

TROUGH DUAL OPTO BOARDS: We have been using **Single OPTO Switch Boards** in our Ball Troughs (as the switch for the Trough Up-Kicker) for a long while now and with great success! Through long-term field testing and design we have produced the **Dual OPTO Switch Board**. Why? Increased reliability and handling of the flow of pinballs in and out of the Ball Trough. In our past games *Baywatch™* through *Viper™* the Ball

Trough Design used only a **Single OPTO Switch** at the Trough Up-Kicker. This designed proved itself reliable. However, as we strive continuously for improvements, we have found by using a **Dual OPTO Switch Board** it will now act as a monitoring device in the event a "double-ball" stack occurs at the Trough Up-Kicker (a double-ball stack is when a ball sits upon the top of the bottom ball over the Trough Up-Kicker). First introduced in *Lost In Space™* the **Dual OPTO Switch Board** will identify this and allow ball transistion to process faster and fluently. For more on troubleshooting, see **Section 3, Chapter 2, Go To Diagnostics Menu** (then Go To Switch Menu) or **Section 5, Chapter 4, Printed Circuit Boards (PCBs), Trough Up-Kicker Dual OPTO Boards Theory of Operation & Schematic, ...Component Layout & Parts, OPTO Troubleshooting and Trough Dual OPTO Boards Alignment (Test for LED1 & LED2)**.

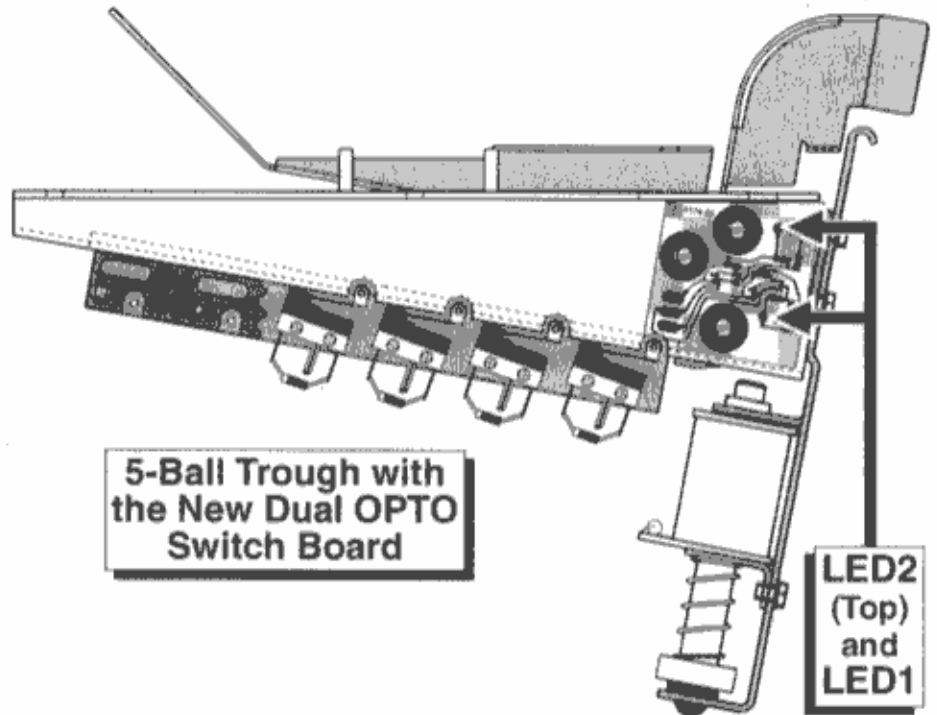

New to our Pinball Games?

Don't forget to go over **Section 3, Chapter 1, Portals™ Service Menu Introduction**. If using *Diagnostics...very useful!* And, as always, if you get stuck? Comments? Questions? Call Technical Support at 800-542-5377 or 708-345-7700.

▼ BACKBOX LAYOUT LOCATIONS: FUSES, BRIDGES, RELAYS & ROMs ▼

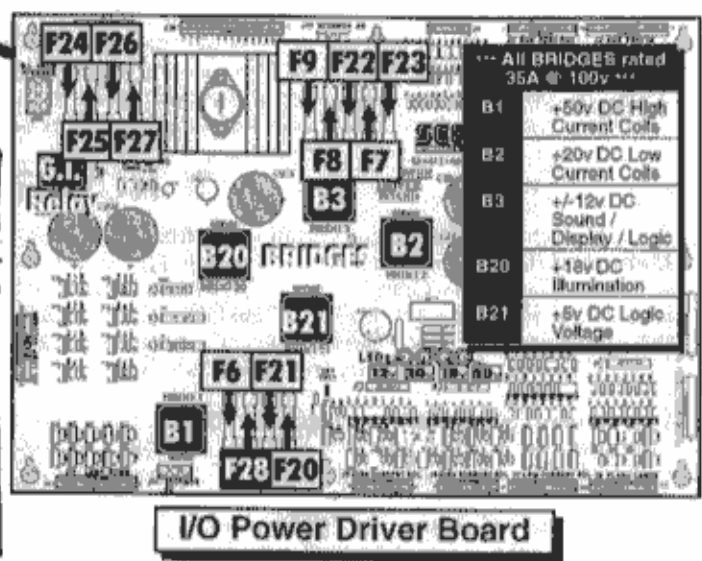
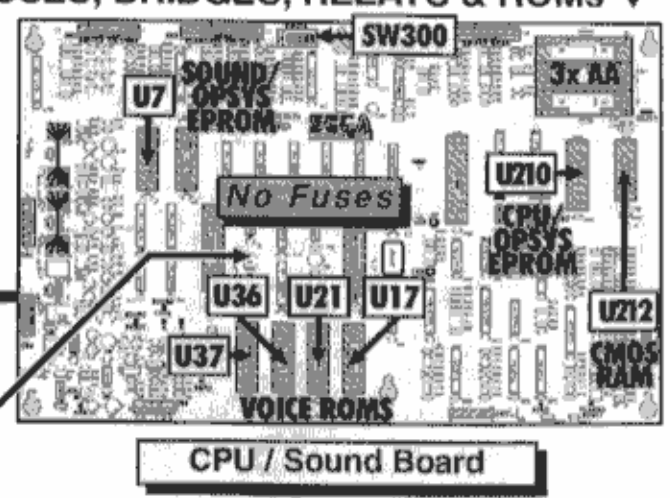
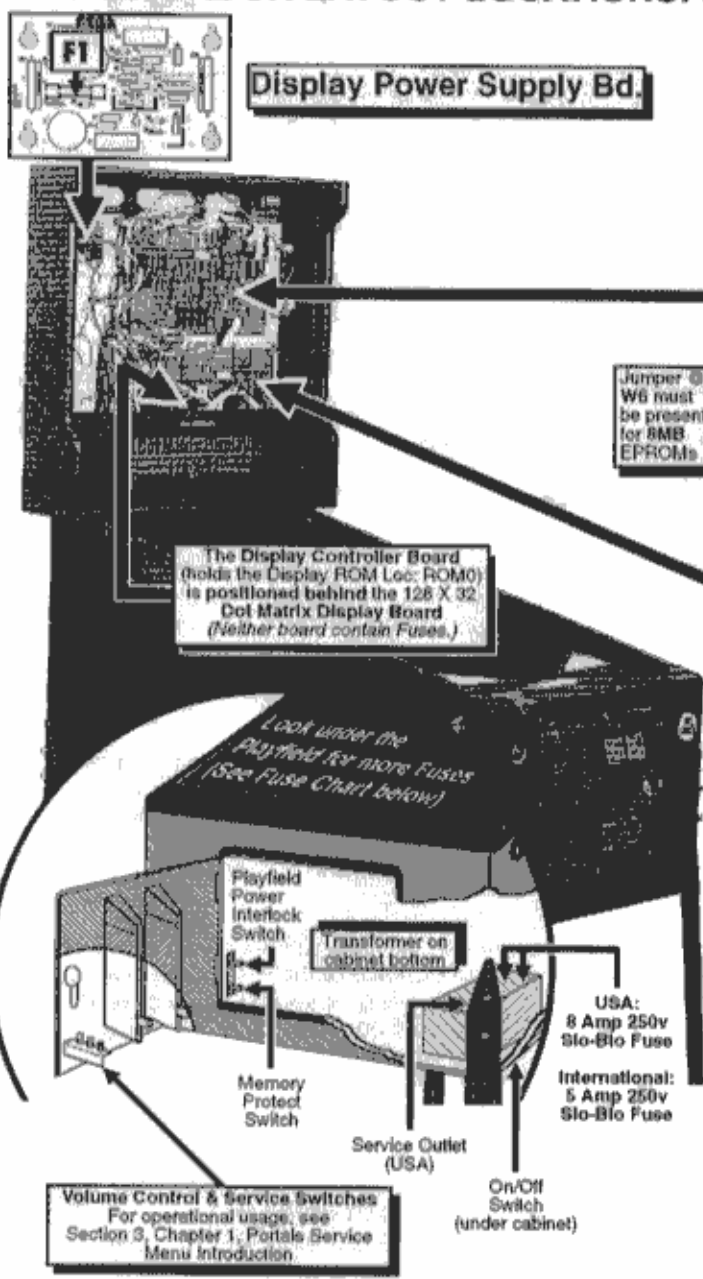

CAUTION: For continued protection against risk of fire, replace only with same type of fuse having the same electrical rating!

QUICK REFERENCE FUSE CHART		
Backbox Fuses		
LOC: DISPLAY POWER SUPPLY (P.S.) BOARD		
F1	1/4A 250v S.B.	90v DC High Voltage Display
LOC: I / O POWER DRIVER BOARD		
F6	7A 250v S.B.	50v DC Primary High Power Coils/Flippers
F7	5A 250v S.B.	20v DC Low Power Coils
F8	5A 250v S.B.	12v DC Logic Power
F9	5A 250v S.B.	12v DC Logic Power
F20	3A 250v S.B.	50v DC Not Used / Spare
F21	3A 250v S.B.	50v DC Coils
F22	8A 250v S.B.	18v DC Controlled Lamps
F23	4A 250v S.B.	5v DC Logic
F24	5A 250v S.B.	6.3v AC G.I. Lamps (BRN-WHT to WHT-BRN)
F25	5A 250v S.B.	6.3v AC G.I. Lamps (YEL to WHT-YEL)
F26	5A 250v S.B.	6.3v AC G.I. Lamps (GRN to WHT-GRN)
F27	5A 250v S.B.	6.3v AC G.I. Lamps (VIO to WHT-VIO)
F28	3A 250v S.B.	24v AC Not Used / Spare
Cabinet Fuses		
LOC: SERVICE (AC) OUTLET BOX (Cabinet Bottom)		
n/a	8A 250v S.B.	115v AC Main Fuse Line (Domestic or USA)
n/a	5A 250v S.B.	220v AC Main Fuse Line (International)

For Backbox & Cabinet General Parts, see Section 4, Chapter 1: Parts Identification & Location (The Pink Pages)
 For Schematics and/or Component Parts on above Boards, see Sec. 5, Chp. 4, Printed Circuit Boards (PCBs) (The Yellow Pages)

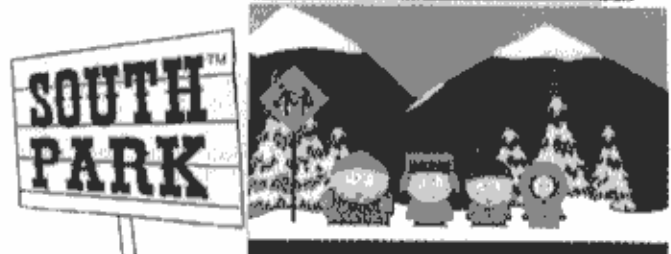

QUICK REFERENCE FUSE CHART		
South Park Playfield Fuses		
LOC: UNDER PLAYFIELD (By Assemblies Listed)		
n/a	3A 250v S.B.	50v DC RL Flipper (BLU-YEL--RED-YEL)
n/a	3A 250v S.B.	50v DC LL Flipper (GRY-YEL--RED-YEL)

+ Find-It-In-Front:
DR. Dr. Pinball



▼ FIND-IT-IN-FRONT: DR. PINBALL SECTION EXPLAINED ▼

The key technical data from various parts of the manual were extracted and combined into the "Find-It-In-Front: Dr. Pinball Section." This section (pages DR. ① - ⑩) will assist the technician in locating important technical information needed to troubleshoot the Pinball Machine. Dr. Pinball is also available on the game in the **Portals™ Service Menu**. This variation is in a Flow Chart Help Format. To get into the **Portals™ Service Menu**:

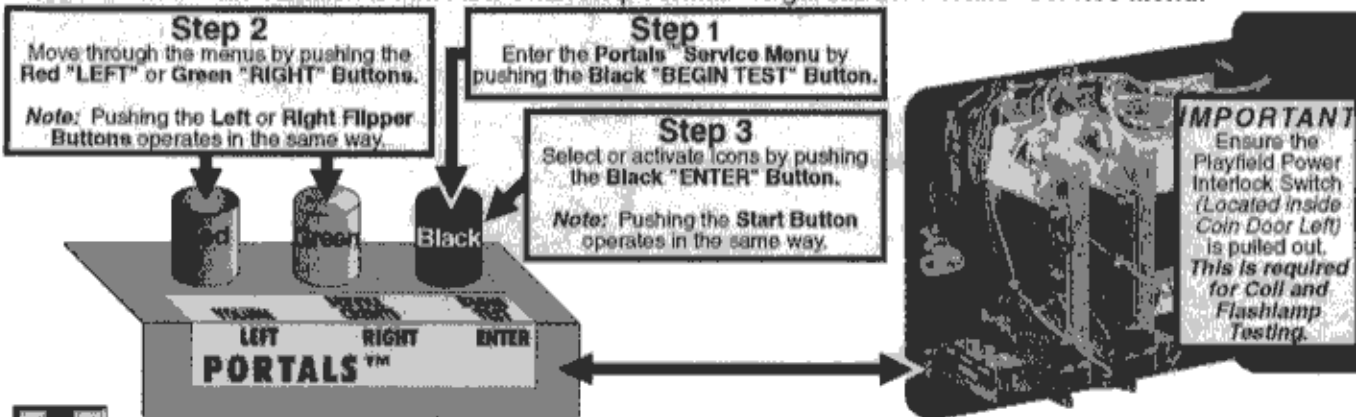

In our **Portals™ Service Menu**, selecting the "DR." Icon will bring the operator/technician into Dr. Pinball (Flow Chart Menus), the "on-screen" diagnostic aide. This is a feature that will allow you to utilize the power of the micro-processor assisting in troubleshooting a problem with the machine in a Flow Chart format (*Just follow along & answer the questions.*).

▼ HOW IT WORKS ▼

First, the operator/technician must enter the Service Mode (for a complete description of the **Portals™ Service Menu** and **ICONS** see Section 3, Chapter 1). To get into the Service Menu Mode: • Power-up game (if not already) & open the Coin Door. • On the Coin Door is the Portals™ Service Switch Set (**Red, Green & Black Buttons**). Push down the **Black "BEGIN TEST" Button**. Looking at the Video Display you will momentarily see the introductory screen "Service Menu" with a satellite flying from right to left pulling a banner "Portals™ © SEGA PINBALL, INC.," followed by the **MAIN MENU**.

While in the **MAIN MENU**, select the "DIAG" Icon, then select the Cross "DR." Icon. This will bring you (the operator / technician) into **DR. PINBALL** (Flow Chart Menus) which offers you a choice of three (3) Sub-Menus: Coil "DR.," Switch "DR." and Lamp "DR." Icons. Selecting a particular sub-menu will give you a choice of which specific Flipper, Coil, Switch or Lamp circuit needs to be diagnosed. The display will now ask a question or give a procedure to follow such as "Does the lamp turn on?" or "Check bridge rectifier BR-20, if short replace." When Dr. Pinball asks a question or request a procedure the Dr. will expect a response such as "no" or "yes" (see below examples of the *Mini-Icons* which will prompt the operator). You the operator/technician must respond by using your **Flipper Buttons** to "SELECT" a *Mini-Icon* and the **Start Button** to "ENTER" your selection.

Note: The "Portals" service switches located on the coin door can also be used to select and enter Mini-Icons. In switch test this is required since flipper and start switches are part of the test.



The following are the *Mini-Icons* with explanations for the Dr. Pinball Sub-Menus:

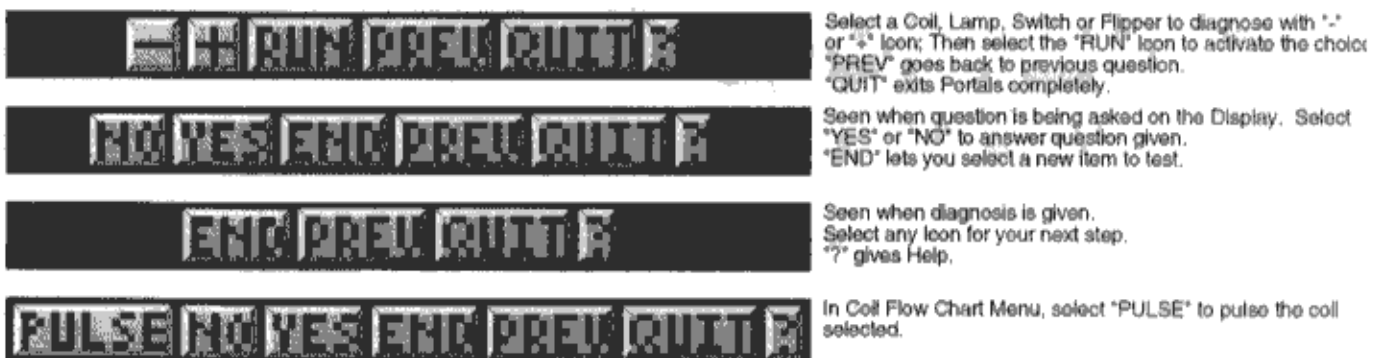

INSTALL 5 BALLS!



This is a 5-Ball Pinball children...



▼ DIAGNOSTIC AIDS ▼

The *display reads* "OPERATOR ALERT..." — A message displayed during Game Mode or Power-Up to alert the operator of a problem.

OPERATOR ALERT works by monitoring any *switch activated coil* that has the potential to trap a ball when disabled (e.g. in the Auto Launch, Scoop, Eject, etc.). If this assembly has a closed switch indicating a ball is stuck or the switch is *stuck closed*, the CPU Board will activate the coil ten times. If the switch remains closed, the game will display a message indicating there is a problem (e.g. "OPERATOR ALERT AUTO LAUNCH NOT WORKING"). This not only warns the operator of a problem immediately, but indicates exactly where the operator should look to resolve it.

The *display flashes* "OPEN THE COIN DOOR" — This indicates that CMOS RAM memory (CPU Loc. U212) has been corrupted.

This is caused by either failure in memory (e.g. batteries are dead or faulty RAM) or upon installation of updated version of code. Opening the Coin Door will initiate a Factory Restore, by opening the Memory Protect Switch. Check battery voltage at CMOS RAM with power off.

▼ CPU DIP SWITCH SETTINGS, LOC. SW300 CPU/SOUND BOARD ▼ CUSTOM FACTORY ADJUSTMENTS BY COUNTRY*

CPU COUNTRY SETTING: Pos. 1 2 3 4 5 6 7 8	CPU COUNTRY SETTING: Pos. 1 2 3 4 5 6 7 8	CPU COUNTRY SETTING: Pos. 1 2 3 4 5 6 7 8
USA * ON: [] [] [] [] [] [] [] [] OFF: [] [] [] [] [] [] [] []	FRANCE ON: [] [] [] [] [] [] [] [] OFF: [] [] [] [] [] [] [] []	NORWAY ON: [] [] [] [] [] [] [] [] OFF: [] [] [] [] [] [] [] []
CPU COUNTRY SETTING: Pos. 1 2 3 4 5 6 7 8	CPU COUNTRY SETTING: Pos. 1 2 3 4 5 6 7 8	CPU COUNTRY SETTING: Pos. 1 2 3 4 5 6 7 8
AUSTRIA ON: [] [] [] [] [] [] [] [] OFF: [] [] [] [] [] [] [] []	GERMANY ON: [] [] [] [] [] [] [] [] OFF: [] [] [] [] [] [] [] []	SWEDEN ON: [] [] [] [] [] [] [] [] OFF: [] [] [] [] [] [] [] []
CPU COUNTRY SETTING: Pos. 1 2 3 4 5 6 7 8	CPU COUNTRY SETTING: Pos. 1 2 3 4 5 6 7 8	CPU COUNTRY SETTING: Pos. 1 2 3 4 5 6 7 8
BELGIUM ON: [] [] [] [] [] [] [] [] OFF: [] [] [] [] [] [] [] []	ITALY ON: [] [] [] [] [] [] [] [] OFF: [] [] [] [] [] [] [] []	SWITZERLAND ON: [] [] [] [] [] [] [] [] OFF: [] [] [] [] [] [] [] []
CPU COUNTRY SETTING: Pos. 1 2 3 4 5 6 7 8	CPU COUNTRY SETTING: Pos. 1 2 3 4 5 6 7 8	CPU COUNTRY SETTING: Pos. 1 2 3 4 5 6 7 8
BRAZIL ON: [] [] [] [] [] [] [] [] OFF: [] [] [] [] [] [] [] []	JAPAN ON: [] [] [] [] [] [] [] [] OFF: [] [] [] [] [] [] [] []	UK ON: [] [] [] [] [] [] [] [] OFF: [] [] [] [] [] [] [] []
CPU COUNTRY SETTING: Pos. 1 2 3 4 5 6 7 8	CPU COUNTRY SETTING: Pos. 1 2 3 4 5 6 7 8	CPU COUNTRY SETTING: Pos. 1 2 3 4 5 6 7 8
CANADA ON: [] [] [] [] [] [] [] [] OFF: [] [] [] [] [] [] [] []	NETHERLANDS (HOLLAND / DUTCH) ON: [] [] [] [] [] [] [] [] OFF: [] [] [] [] [] [] [] []	UK FOR NEW 50p 2c COIN MECH ON: [] [] [] [] [] [] [] [] OFF: [] [] [] [] [] [] [] []

*All countries not noted use the "USA Setting"

▼ ROM SUMMARY TABLE ▼

* Note: The CPU/Sound Board must have a Jumper at W6 to accept 8MB ROMs.

I.C. NAME	TYPE	BOARD NAME	LOC	PART N ^o
Game ROM	1MB	CPU / Sound Board	U210	965-0301-71
Voice ROM 1 *	8MB	CPU / Sound Board	U17	965-0302-71
Voice ROM 2 *	8MB	CPU / Sound Board	U21	965-0303-71
Voice ROM 3 *	8MB	CPU / Sound Board	U36	965-0304-71
Voice ROM 4 *	8MB	CPU / Sound Board	U37	965-0305-71
Sound EPROM	512K	CPU / Sound Board	U7	965-0306-71
Display EPROM	4MB	Display Controller Bd.	ROM 0	965-0307-71
Display EPROM	Not Used	Display Controller Bd.	ROM 1	Not Used



Find-It-In-Front:
Dr. Pinball





From the Main Menu
in Portals
GO TO DIAGNOSTICS
MENU



From the Diagnostics
Menu
GO TO SWITCH
MENU



From the Switch
Menu
GO TO SWITCH OR
ACTIVE SWITCH TEST



From the Switch
Menu
GO TO DEDICATED
SWITCH TEST

SWITCH MATRIX GRID & DEDICATED SWITCHES

Column (18v)	1: Q1	2: Q2	3: Q3	4: Q4	5: Q5	6: Q6	7: Q7	8: Q8	QND	Ground
Row (Return)	GRN-BRN CN5-P1	GRN-RED CN5-P3	GRN-ORG CN5-P4	GRN-YEL CN5-P5	GRN-BLK CN5-P6	GRN-BLU CN6-P7	GRN-VIO CN6-P8	GRN-GRY CN5-P9	IC U206 #POTS	BLK CN5-P1 - P11
1: U400 WHT-BRN CN7-P9	LEFT RAMP ENTER (In Cabinet)	NOT USED	LEFT 5-BANK BOTTOM (Under P1)	RIGHT RAMP ENTER (Above P1)	NOT USED	RIGHT 5-BANK BOTTOM (Under P1)	LEFT TURBO BUMPER (Under P1)	LEFT OUTLANE (Under P1)	1: U206 GRY-BRN CN6-P2	#1 LEFT FLIPPER BUTTON (In Cabinet side)
2: U400 WHT-RED CN7-P11	4TH COIN SLOT (On Coin Door)	5-BALL TROUGH #1 (LEFT) (Under P1)	LEFT 5-BANK #2 (Under P1)	RIGHT RAMP EXIT (Above P1)	RIGHT 3-BANK BOTTOM (Under P1)	KENNY OPTO (Under P1)	RIGHT TURBO BUMPER (Under P1)	LEFT RETURN LANE (Under P1)	2: U206 GRY-RED CN6-P3	#2 LEFT FLIPPER E.O.S. (End-of-Stroke) (In Cabinet side)
3: U400 WHT-ORG CN7-P7	6TH COIN SLOT (On Coin Door)	5-BALL TROUGH #2 (Under P1)	LEFT 5-BANK #3 (Under P1)	NOT USED	RIGHT 3-BANK MIDDLE (Under P1)	UNDER- TROUGH (TOILET) (Under P1)	BOTTOM TURBO BUMPER (Under P1)	LEFT SLINGSHOT (Under P1)	3: U206 GRY-ORG CN6-P4	#3 RIGHT FLIPPER BUTTON (In Cabinet side)
4: U400 WHT-YEL CN7-P5	RIGHT COIN SLOT (On Coin Door)	5-BALL TROUGH #3 (Under P1)	LEFT 5-BANK #4 (Under P1)	NOT USED	RIGHT 3-BANK TOP (Under P1)	UNDER- TROUGH (KENNY) (Under P1)	NOT USED	RIGHT OUTLANE (Under P1)	4: U206 GRY-YEL CN6-P5	#4 RIGHT FLIPPER E.O.S. (End-of-Stroke) (In Cabinet side)
5: U401 WHT-GRN CN7-P5	CENTER COIN SLOT / OBA (On Coin Door)	5-BALL TROUGH #4 (Under P1)	LEFT 5-BANK TOP (Under P1)	NOT USED	CENTER BUMPER TARGET LT (Under P1)	SVUK (Under P1)	NOT USED	RIGHT RETURN LANE (Under P1)	5: U206 NOT USED GRY-GRN CN6-P7	NOT USED
6: U401 WHT-BLU CN7-P3	LEFT COIN SLOT (On Coin Door)	5-BALL TROUGH VUK OPTO (Under P1)	CENTER 3-BANK LEFT (Under P1)	NOT USED	POP BUMPER TARGET RT (Under P1)	VUK (Under P1)	START BUTTON (On Coin Door)	RIGHT SLINGSHOT (Under P1)	6: U206 GRY-BLU CN6-P11	#6 VOLUME (RED BUTTON) (In Test: LEFT) (On Coin Door)
7: U401 WHT-VIO CN7-P2	5TH COIN SLOT (On Coin Door)	5-BALL STACKING OPTO (Under P1)	CENTER 3-BANK MIDDLE (Under P1)	NOT USED	NOT USED	LEFT ORBIT (TO VUK) (Under P1)	SLAM TILT (On Coin Door)	NOT USED	7: U206 GRY-VIO CN6-P9	#7 SERV. CRED. (GREEN BUTTON) (In Test: RIGHT) (On Coin Door)
8: U401 WHT-GRY CN7-P1	RIGHT TURBO BUMPER (On Cabinet side)	SHOOTER LANE (Under P1)	CENTER 3-BANK RIGHT (Under P1)	NOT USED	NOT USED	UNDER- TROUGH SVUK (Under P1)	PLUMB BOB TILT (Under Cabinet)	NOT USED	8: U206 GRY-BLK CN6-P10	#8 BEGIN TEST (BLACK BUTTON) (In Test: ENTER) (On Coin Door)



From the Diagnostics
Menu
GO TO LAMP
MENU

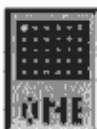

From the Lamp
Menu
GO TO SINGLE
LAMP TEST

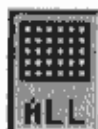

From the Lamp
Menu
GO TO TEST
ALL LAMPS



From the Lamp
Menu
GO TO ROW OR
COLUMN TEST

LAMP MATRIX GRID

Column (18v)	1: U17	2: U16	3: U15	4: U14	5: U13	6: U12	7: U11	8: U10
Row (GND)	YEL-BRN J13-P9	YEL-RED J13-P8	YEL-ORG J13-P7	YEL-BLK J13-P6	YEL-GRN J13-P5	YEL-BLU J13-P4	YEL-VIO J13-P1	YEL-GRY J13-P1
1: Q33 RED-BRN J12-P1	CHEF FACE #555 Bulb 1	CHEF #2 #555 Bulb 2	CHEF #3 #555 Bulb 3	CHEF #4 #555 Bulb 4	CHEF ARROW #555 Bulb 5	MYSTERY #555 Bulb 6	SPOOKY VISION #555 Bulb 7	EXTRA BALL #555 Bulb 8
2: Q34 RED-BLK J12-P2	STAN FACE #555 Bulb 9	STAN #2 #555 Bulb 10	STAN #3 #555 Bulb 11	STAN #4 #555 Bulb 12	STAN ARROW #555 Bulb 13	SKILL SHOT #555 Bulb 14	VOLCANO #555 Bulb 15	ANAL PROBE #555 Bulb 16
3: Q35 RED-ORG J12-P3	KENNY FACE #555 Bulb 17	KENNY #2 #555 Bulb 18	KENNY #3 #555 Bulb 19	KENNY #4 #555 Bulb 20	KENNY ARROW #555 Bulb 21	SUPER JACKPOT #555 Bulb 22	MULTIBALL READY #555 Bulb 23	SOUTH PARK SIGN #555 Bulb 24
4: Q36 RED-YEL J12-P4	KYLE FACE #555 Bulb 25	KYLE #2 #555 Bulb 26	KYLE #3 #555 Bulb 27	KYLE #4 #555 Bulb 28	KYLE ARROW #555 Bulb 29	KENNY ASSEMBLY #555 Bulb 30	NOT USED	NOT USED
5: Q37 RED-GRN J12-P5	CARTMAN FACE #555 Bulb 31	CARTMAN #2 #555 Bulb 32	CARTMAN #3 #555 Bulb 33	CARTMAN #4 #555 Bulb 34	CARTMAN ARROW #555 Bulb 35	LEFT TUR- BO BUMPER #555 Bulb 36	RIGHT TUR- BO BUMPER #555 Bulb 37	BTM TUR- BO BUMPER #555 Bulb 38
6: Q38 RED-BLU J12-P6	LEFT 5-BANK BOTTOM #555 Bulb 39	LEFT 5-BANK #2 #555 Bulb 40	LEFT 5-BANK #3 #555 Bulb 41	LEFT 5-BANK #4 #555 Bulb 42	LEFT 5-BANK TOP #555 Bulb 43	TOILET S-U LT #555 Bulb 44	NOT USED	TOILET S-U RT #555 Bulb 45
7: Q39 RED-VIO J12-P8	NOT USED	RT. 3-BANK BOTTOM #555 Bulb 46	RT. 3-BANK MIDDLE #555 Bulb 47	RT. 3-BANK TOP #555 Bulb 48	LEFT OUTLANE #555 Bulb 49	LEFT RE- TURN LANE #555 Bulb 50	RIGHT RE- TURN LANE #555 Bulb 51	RIGHT OUTLANE #555 Bulb 52
8: Q40 RED-GRY J12-P11	MR. HANKEY: BOTTOM #555 Bulb 53	MR. HANKEY: BODY #555 Bulb 54	MR. HANKEY: LT HAND #555 Bulb 55	MR. HANKEY: RT HAND #555 Bulb 56	MR. HANKEY: HEAD #555 Bulb 57	MR. HANKEY: HAT #555 Bulb 58	POP BUMPER TARGET LT #555 Bulb 59	POP BUMPER TARGET RT #555 Bulb 60
9: Q41 NOT USED RED-WHY J12-P10	NOT USED	NOT USED	NOT USED	NOT USED	NOT USED	NOT USED	NOT USED	NOT USED
10: Q42 NOT USED RED J12-P11	NOT USED	NOT USED	NOT USED	NOT USED	NOT USED	NOT USED	NOT USED	NOT USED



SWITCH MATRIX GRID LOCATIONS

LAMP MATRIX GRID LOCATIONS

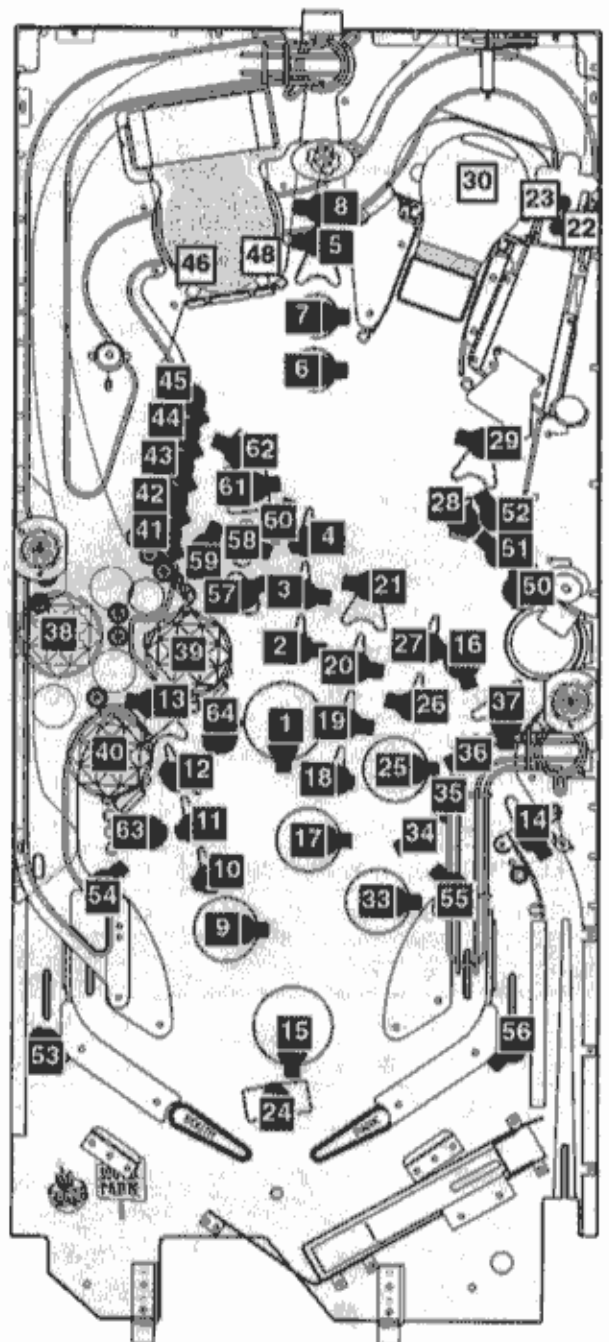
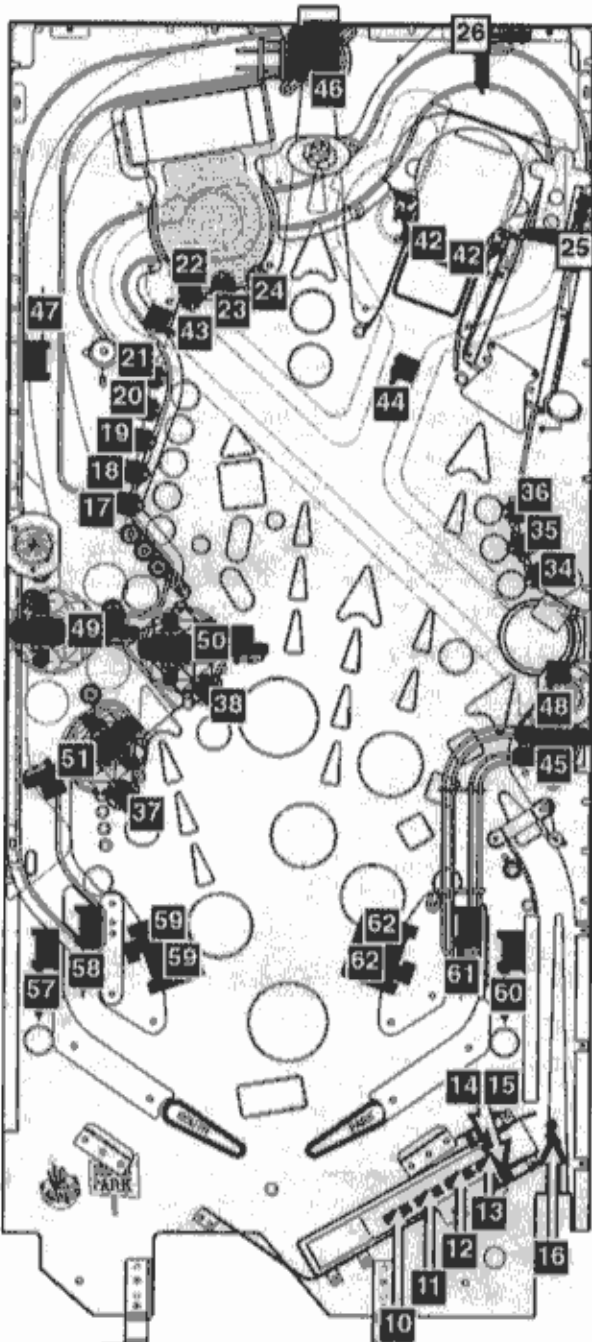

Legend Note: = Switches/Lamps mounted above playfield. = Switches/Lamps mounted below the playfield.

TYPICAL SWITCH SCHEMATIC

DEDICATED SWITCH SCHEMATIC

TYPICAL LAMP SCHEMATIC

(Column: Switch Drive Wire)

(Row: Switch Return Wire)

Dedicated Sw. Inputs

Ground

GRN-XXX

WHT-XXX

GRY-XXX

BLK

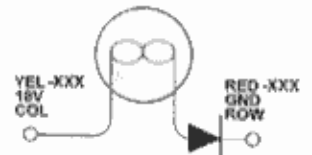

Note:
All Switches require diodes.
Some diodes are located on
Terminal Strips (under playfield)
& not on the switch itself.
D iode
O n
T ermin
S trip

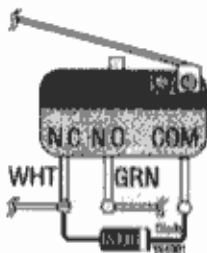

Note:
All Lamps require diodes.
Some diodes are located on
Terminal Strips (under playfield)
& not on the lamp itself.
D iode
O n
T ermin
S trip

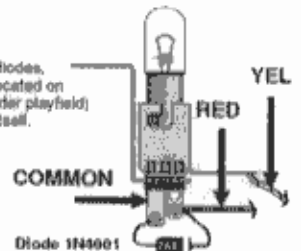

Find-It-In-Front:
Dr. Pinball





From the Main Menu
In Portals
GO TO DIAGNOSTICS
MENU



From the Diagnostics
Menu
GO TO COIL
MENU



From the Coil
Menu
GO TO COIL
TEST



From the Coil
Menu
GO TO CYCLING
COILS

COILS DETAILED CHART TABLE

High Current Coils Group 1		Drive Transistor (D.T.)	Driver Output Board	D.T. Control Line Color	D.T. Control Line Connect	Power Line Color	Power Line Connection	Power Voltage	Coil GA/Turn or Bulb Type
#1	TROUGH UP-KICKER	Q1	I/O Pwr. Drvr.	BRN-BLK	J8-P1	YEL-VIO	J10-P4/5	50v dc	26-1200 090-5044-00T
#2	AUTO LAUNCH	Q2	I/O Pwr. Drvr.	BRN-RED	J8-P3	YEL-VIO	J10-P4/5	50v dc	24-940 090-5036-00T
#3	SUPER VUK	Q3	I/O Pwr. Drvr.	BRN-ORG	J8-P4	YEL-VIO	J10-P4/5	50v dc	24-940 090-5036-00T
#4	TOP VUK	Q4	I/O Pwr. Drvr.	BRY-YEL	J8-P5	YEL-VIO	J10-P4/5	50v dc	26-1200 090-5044-00T
#5	TOILET SEAT LID	Q5	I/O Pwr. Drvr.	BRN-GRN	J8-P6	BRN	J7-P1	20v dc	23-1100 090-5030-00T
#6	MR. HANKEY LATCH	Q6	I/O Pwr. Drvr.	BRN-BLU	J8-P7	YEL-VIO	J10-P4/5	50v dc	29-1000 090-5059-00
#7	FLASH POPS *4	Q7	I/O Pwr. Drvr.	BRN-VIO	J8-P8	ORG	J6-P10	20v dc	#89 Bulb 185-5000-89
#8	EUROPEAN TOKEN DISPENSER	Q8	I/O Pwr. Drvr.	BRN-GRY	J8-P9	YEL-VIO	J10-P4/5	50v dc	DL455 015-0000-01

High Current Coils Group 2		Drive Transistor (D.T.)	Driver Output Board	D.T. Control Line Color	D.T. Control Line Connect	Power Line Color	Power Line Connection	Power Voltage	Coil GA/Turn
#9	LEFT TURBO BUMPER	Q9	I/O Pwr. Drvr.	BLU-BRN	J9-P1	YEL-VIO	J10-P4/5	50v dc	26-1200 090-5044-00T
#10	RIGHT TURBO BUMPER	Q10	I/O Pwr. Drvr.	BLU-RED	J9-P2	YEL-VIO	J10-P4/5	50v dc	26-1200 090-5044-00T
#11	BOTTOM TURBO BUMPER	Q11	I/O Pwr. Drvr.	BLU-ORG	J9-P4	YEL-VIO	J10-P4/5	50v dc	26-1200 090-5044-00T
#12	LEFT SLINGSHOT	Q12	I/O Pwr. Drvr.	BLU-YEL	J9-P5	BRN	J7-P1	20v dc	23-800 090-5001-00T
#13	MR. HANKEY (DOWN)	Q13	I/O Pwr. Drvr.	BLU-GRN	J9-P6	YEL-VIO	J10-P4/5	50v dc	23-1100 090-5030-00T
#14	KENNY PIVOT (DEAD)	Q14	I/O Pwr. Drvr.	BLU-BLK	J9-P7	YEL-VIO	J10-P4/5	50v dc	22-1080 090-5039-00T
#15	LEFT FLIPPER (50v RED/YEL)	Q15	I/O Pwr. Drvr.	ORG-GRY	J9-P8	RED-YEL GRY-YEL	J10-P1/2	50v dc	23-1100 090-5030-00T
#16	RIGHT FLIPPER (50v RED/YEL)	Q16	I/O Pwr. Drvr.	ORG-VIO	J9-P9	RED-YEL RED-VIO	J10-P1/2	50v dc	23-1100 090-5030-00T

Low Current Coils Group 1		Drive Transistor (D.T.)	Driver Output Board	D.T. Control Line Color	D.T. Control Line Connect	Power Line Color	Power Line Connection	Power Voltage	Coil GA/Turn or Motor
#17	RIGHT SLINGSHOT	Q17	I/O Pwr. Drvr.	VIO-BRN	J7-P2	BRN	J7-P1	20v dc	23-800 090-5001-00T
#18	FLASH TOP VUK *1	Q18	I/O Pwr. Drvr.	VIO-RED	J7-P3	ORG	J6-P10	20v dc	#89 Bulb 185-5000-89
#19	KENNY LT	Q19	I/O Pwr. Drvr.	VIO-ORG	J7-P4	BRN	J7-P1	20v dc	24-940 090-5036-00T
#20	KENNY RT	Q20	I/O Pwr. Drvr.	VIO-YEL	J7-P6	BRN	J7-P1	20v dc	24-940 090-5036-00T
#21	LT OUTLANE (UK ONLY)	Q21	I/O Pwr. Drvr.	VIO-GRN	J7-P7	BRN	J7-P1	20v dc	26-1050 090-5048-00T
#22	RT OUTLANE (UK ONLY)	Q22	I/O Pwr. Drvr.	VIO-BLU	J7-P8	BRN	J7-P1	20v dc	26-1050 090-5048-00T
#23	UP/DOWN POST (UK ONLY)	Q23	I/O Pwr. Drvr.	VIO-BLK	J7-P9	BRN	J7-P1	20v dc	23-1100 090-5030-00T
#24	OPTIONAL COIN METER	Q24	I/O Pwr. Drvr.	VIO-GRY	J7-P10	RED	J18-P7	5v dc	Motor 5v 021-2230-00

Flash Lamps (FLASH)		Drive Transistor (D.T.)	Driver Output Board	D.T. Control Line Color	D.T. Control Line Connect	Power Line Color	Power Line Connection	Power Voltage	Bulb Type
#F1	FLASH STAN *2	Q25	I/O Pwr. Drvr.	BLK-BRN	J6-P1	ORG	J6-P10	20v dc	#89 Bulb 185-5000-89
#F2	FLASH CHEF *2	Q26	I/O Pwr. Drvr.	BLK-RED	J6-P2	ORG	J6-P10	20v dc	#89 Bulb 185-5000-89
#F3	FLASH KENNY *2	Q27	I/O Pwr. Drvr.	BLK-ORG	J6-P3	ORG	J6-P10	20v dc	#89 Bulb 185-5000-89
#F4	FLASH KYLE *2	Q28	I/O Pwr. Drvr.	BLK-YEL	J6-P4	ORG	J6-P10	20v dc	#89 Bulb 185-5000-89
#F5	FLASH CARTMAN *2	Q29	I/O Pwr. Drvr.	BLK-GRN	J6-P5	ORG	J6-P10	20v dc	#89 Bulb 185-5000-89
#F6	FLASH KENNY *1 BACK *2	Q30	I/O Pwr. Drvr.	BLK-BLU	J6-P6	ORG	J6-P10	20v dc	#906 Bulb 185-5004-00 #89 Bulb 185-5000-89
#F7	FLASH MR HANKEY/TOILET *2	Q31	I/O Pwr. Drvr.	BLK-VIO	J6-P7	ORG	J6-P10	20v dc	#89 Bulb 185-5000-89
#F8	FLASH SUPER VUK *1	Q32	I/O Pwr. Drvr.	BLK-GRY	J6-P8	ORG	J6-P10	20v dc	#89 Bulb 185-5000-89

Note: In Test Flash Lamps Menu ("Flash" icon), flashers tested are Flash Lamps F1-F8 ONLY. Test all others in Single or Cycling Coil Tests.



COIL LOCATIONS

FLASH LAMP LOCATIONS

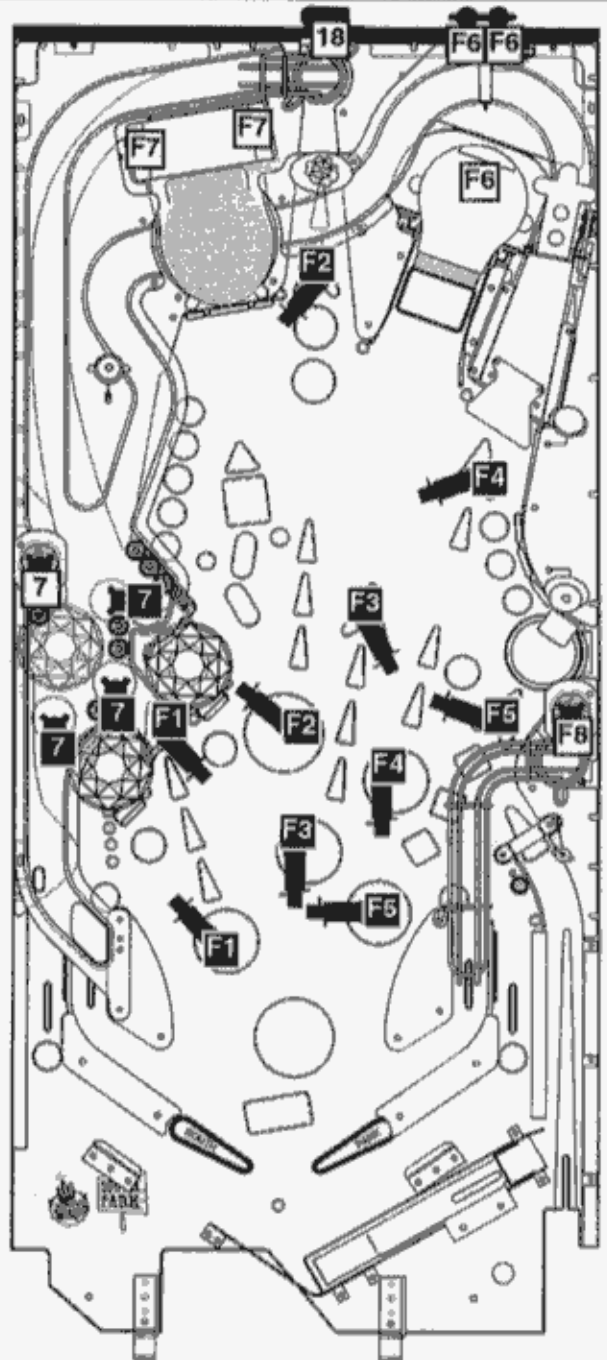
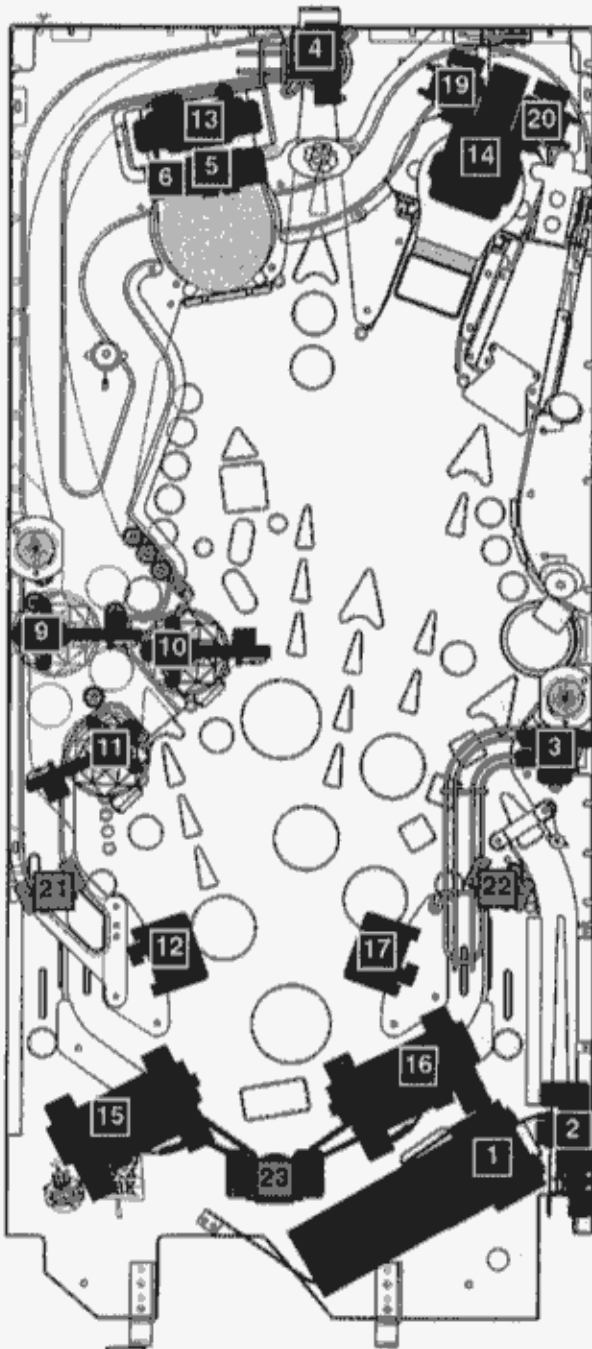

Legend Note: = Coils/Flashes mounted above playfield. = Coils/Flashes mounted below the playfield.

TYPICAL COIL WIRING

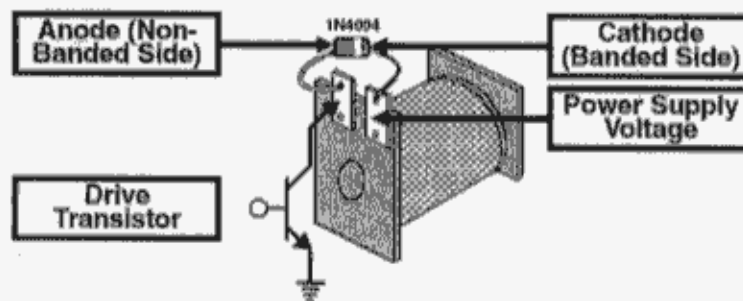

Note:
All Coils require diodes. Some diodes are located on Terminal Strips (under playfield) & not on the coil itself.

- D Diode
- O n
- T Terminal
- S Strip

+
DR. Find-It-In-Front:
Dr. Pinball



DOMESTIC PINBALL & REDEMPTION DISTRIBUTORS



#	STATE/PROVINCE AND CITY	NAME	PHONE	#	STATE/PROVINCE AND CITY	NAME	PHONE
1	AL Birmingham	Birmingham Vending	205-324-7526	31	ND Fargo	M.H. Associates, Inc.	701-282-7877
2	AR N. Little Rock	Godwin Distributing	501-753-1138	32	NE Omaha	Greater American Dist.	402-553-2812
3	AZ Phoenix	Belson West	602-233-0190	33	NJ Springfield	Mid-City Dist.	402-341-5300
4	BC Burnaby (Can.)	Can. Coin Machine	604-420-4008	34	NJ Springfield	State Sales & Service	973-467-9700
5	BC Vancouver (Can.)	Pacific Vending	604-324-2164	35	NV Las Vegas	Belson West	702-740-8484
6	CA Buena Park	Belson West	714-228-7500	36	NV Reno	Reno Game Sales	702-829-2080
7	CA S. San Francisco		415-952-4220	37	NY Garden City Park	T & M Distributing	516-747-0034
8	CO Denver	Warehouse of Games	303-893-8652	38	NY Roslyn Heights	Deith Distributing	516-621-1234
9	CO Denver	Mountain Coin	303-427-2133	39	NY Syracuse	T & M Distributing	315-432-1932
10	CT Williamantic	T & M Distributing	860-456-4231	40	OH Cincinnati	Atlas Distributing	513-771-1909
11	FL Orlando	Birmingham Vending	407-425-1505	41	OH Columbus	Shaffer Distributing, Co.	614-421-6800
12	GA Roswell	Game Exchange/SE, Inc.	770-594-0000	42	OH Macadonia		330-467-4850
13	HI Ewa Beach	50th State Coin Op.	808-682-4561	43	OK Tulsa	Galaxy Distributing, Co.	918-835-1166
14	IA Des Moines	Greater American Dist.	515-244-2828	44	ON Rexdale (Can.)	New Way Sales	416-674-8000
15	IL Elk Grove Village	Atlas Distributing	847-952-7500	45	ON Toronto (Can.)	Starburst Coin Machines	416-251-2122
16	IL Bensenville	Namco Cyberertainment	630-238-2200	46	OR Portland	American Coin	503-233-7000
17	IN Indianapolis	Atlas Distributing	317-786-6892	47	PA Bensalem	State Sales & Service	215-638-1122
18	IN Indianapolis	Shaffer Distributing, Co.	317-899-2530	48	PA Pittsburgh	Green Coin	412-881-8804
19	KS Wichita	United Distributors, Inc.	316-263-6181	49	PA Wilkes-Barre	Superior	717-824-9994
20	KY Louisville	Atlas Distributing	502-966-5266	50	SC Myrtle Beach	Green Coin	803-629-1900
21	LA Metairie	AMA Distributors, Inc.	504-835-3232	51	TN Memphis	Green G.A.M.E.S.	901-353-1000
22	MA E. Long Meadow	Gekay Sales	413-525-2700	52	TX Carrollton	Nickels & Dimes	972-492-3282
23	MD Baltimore	Automated Services	410-646-4100	53	TX Corsicana	Master Sales	903-874-4740
24	MD Baltimore	Weiner Distributing	410-525-2600	54	TX Dallas	Commercial Music	214-741-6381
25	MI Redford	Atlas Distributing	313-794-4880	55	TX Houston		713-523-7366
26	MI Wyoming	Atlas Distributing	616-241-1472	56	TX San Antonio	H.A. Franz, & Co.	210-226-6322
27	MN Bloomington	Hanson Distributing	612-884-6604	57	UT Salt Lake City	Struve Distributing	801-328-1636
28				58	WA Seattle	American Coin	206-764-9020
29	MO St. Louis	Shaffer Distributing, Co.	314-645-3393	59	WI Green Bay	Pioneer Sales & Svc.	920-468-5200
30	NC Archdal	Operators Distributing	910-884-5714	60	WI Menomonee Falls	Pioneer Sales & Svc.	414-781-1420



For Parts and Service, call your local distributor. The numbered locations are general areas. View table and map for corresponding numbered distributor. If your state/province does not have a distributor, call the nearest state/province. Distributors and phone numbers are subject to change. Call Sega Pinball, Inc. Technical Support with any questions or if your distributor cannot help you, at 1-800-542-5377 (USA or Canada or elsewhere at 1-708-345-7700).

DR. 8



Find-It-In-Front:
Dr. Pinball



INTERNATIONAL DISTRIBUTORS

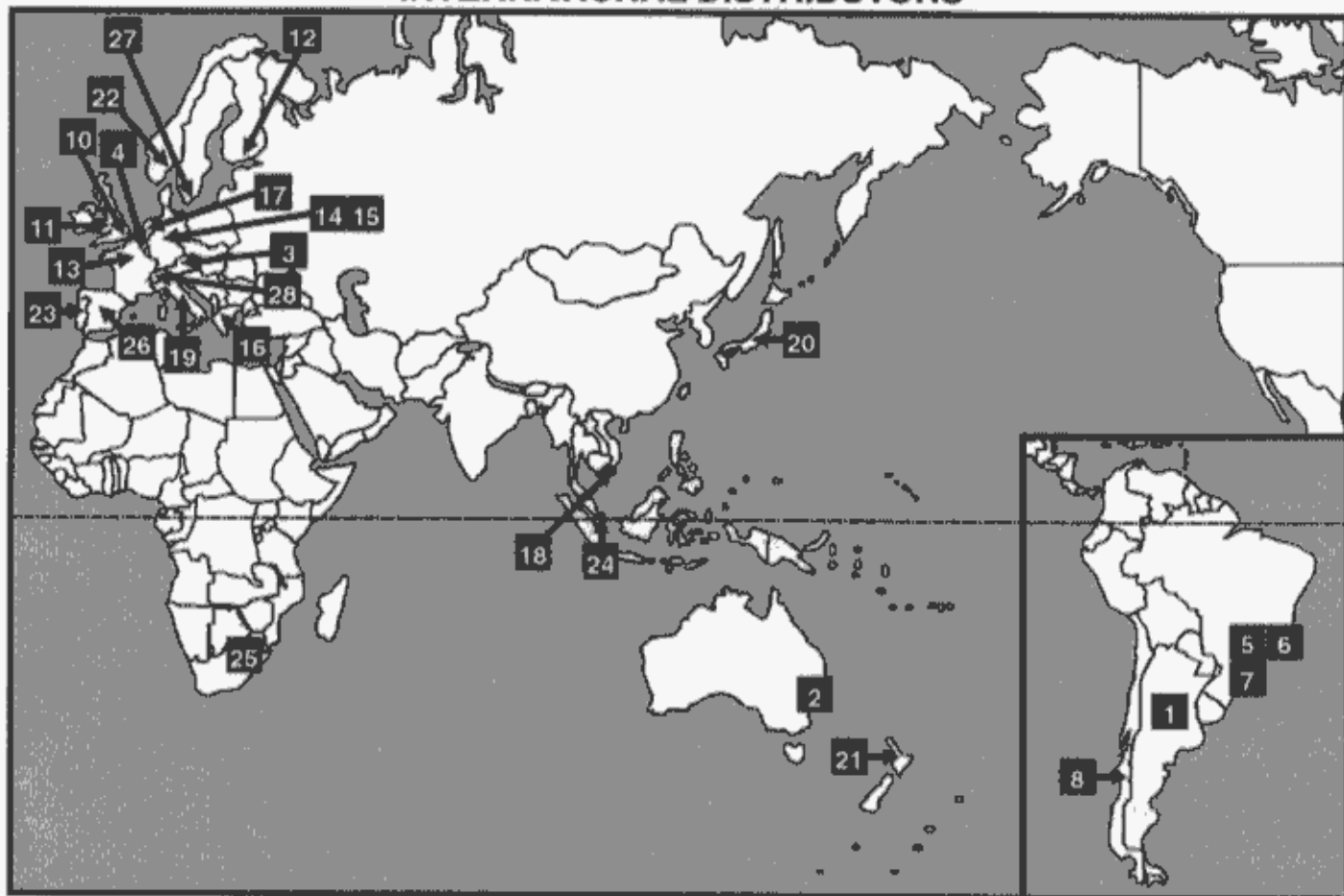

#	COUNTRY AND CITY	NAME	PHONE (-011)	#	COUNTRY AND CITY	NAME	PHONE (-011)
1	Argentina, Urquiza	Florenca	54-232-5532	15	Germany, Hannover	Baily Wulff	49-511-358-5343
2	Australia, Matraville	Amusement Mach. Dist.	61-29-316-6000	16	Greece, Athens	Greece Coin	30-1-554-1608
3	Austria, Grazerstrasse	Rupp Austria	43-34-528-6105	17	Holland, 's-Hertogenbosch	Érrel Industries	31-73-645-6111
4	Belgium, Brussels	Splln S.A.	32-43-62-7677	18	Hong Kong, Kwai Fong	Bondeal Limited	85-2-487-9089
5	Brazil, Sao Paulo	Parkland	55-11-792-42864	19	Italy (RSM), Serravalle	Technoplay Sa	39-54-990-0361
6		Unimax	55-11-533-5615	20	Japan, Tokyo	Data East, Corp.	81-35-370-0708
7		Universe	55-11-575-0731	21	New Zealand, Auckland	Amco Machine Supp.	64-9-846-7606
8	Chile, Santiago	Cuinsa	56-2-696-0167	22	Norway, Oslo	Vendomatic	47-2-216-0830
9		Universe Electronics	56-2-235-7822	23	Portugal, Amadora	Jacinto & Martins	35-11-495-1868
10	England, London	Electrocoin	44-181-965-2055	24	Singapore, Singapore	Valibel Technologies	65-748-8404
11	So. Wales, Cardiff	Electrocoin	44-22-261-5100	25	South Africa, Lalucia	Unimac	27-3-152-5544
12	Finland, Espoo	Pelika Ray Oy	35-8-943-7091	26	Spain, Madrid	Sente S.A.	34-1-541-7112
13	France, Aubervilliers	PLF Sa	33-14-811-3131	27	Sweden, Malmo	Truemax AB	46-40-153-635
14	Germany, Berlin	Baily Wulff	49-3-062-0020	28	Switzerland, Harkingen	Novomat Ag	41-62-398-4061



For Parts and Service, call your local distributor. The numbered locations are general areas. View table and map for corresponding numbered distributor. If your country does not have a distributor, call the nearest country. Distributors and phone numbers are subject to change. Call Sega Pinball, Inc. Technical Support with any questions or if your distributor cannot help you, at 1-708-345-7700.



Dr. Pinball
Find-It-In-Front:



DR. 9

POWER REQUIREMENTS

⚠ This game *must be connected to a properly grounded outlet to reduce shock hazard* & insure proper game operation. See Sec. 5, Schematics & Troubleshooting, Chp. 3, Cabinet Wiring (Transformer Power Wiring), for transformer connections required for **Normal, High, and Low Line** conditions. **⚡**

Normal Line:	110v AC - 125v AC @ 60Hz	
Domestic uses an 8AMP 250v Slo-Blo Fuse.	AVG OPERATION CURRENT: 2.8AMP WATTAGE: 329w	MAX OPERATION CURRENT: 8AMP WATTAGE: 940w
High Line:	218v AC - 240v AC @ 50Hz	
Export uses 5AMP 250v Slo-Blo Fuses. <small>(*England & Hong Kong use an 8-amp 250v 5/B Fuse.)</small>	AVG OPERATION CURRENT: 1.8AMP WATTAGE: 412w	MAX OPERATION CURRENT: 5AMP 8AMP* WATTAGE: 1145w 1832w*
Low Line:	95v AC - 108v AC @ 50Hz / 60Hz	
Export Japan Only uses an 8AMP 250v Slo-Blo Fuse.	AVG OPERATION CURRENT: 2.6AMP WATTAGE: 264w	MAX OPERATION CURRENT: 8AMP WATTAGE: 812w

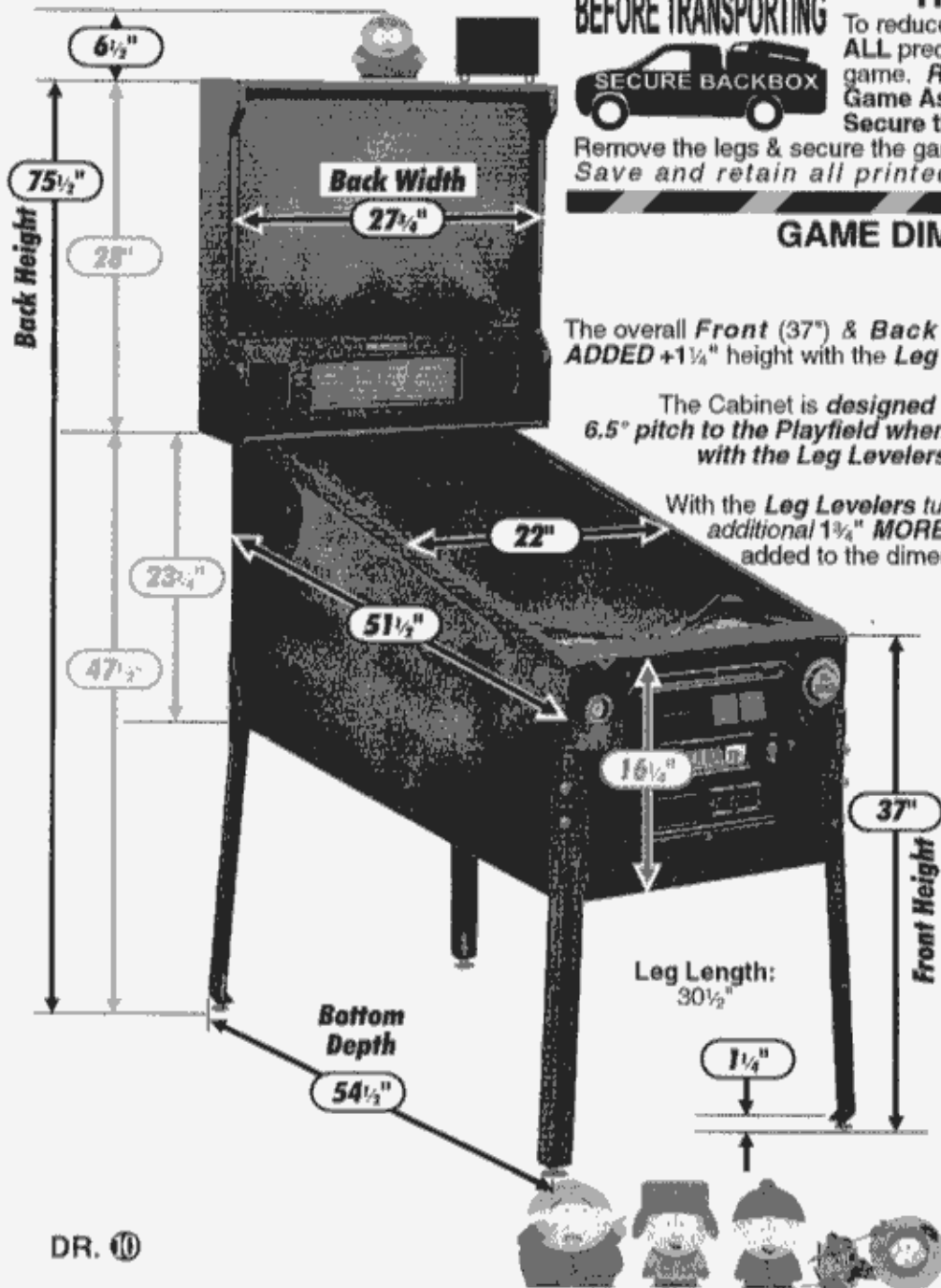

BEFORE TRANSPORTING



Remove the legs & secure the game within the transporting vehicle. *Save and retain all printed information on the game.*

TRANSPORTATION

To reduce the possibility of damage, observe **ALL** precautions whenever transporting the game. *Read & follow Section 1, Chapter 1, Game Assembly Procedures, & How to Secure the Backbox for Transporting.*

GAME DIMENSIONS

The overall **Front** (37") & **Back** (75½") dimensions reflect the **ADDED +1¼"** height with the **Leg Levelers** turned all the way in:

The Cabinet is *designed to give the recommended 6.5° pitch to the Playfield when all four (4) Legs are installed with the Leg Levelers turned all the way in.*

With the **Leg Levelers** turned all the way out, an **additional 1¼" MORE** to the overall height should be added to the dimensions.

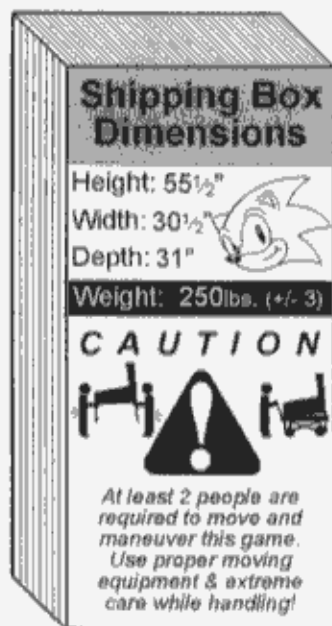

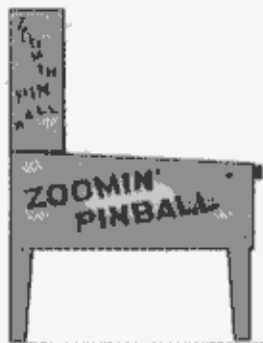

General Table of Contents

See Sections 3 & 5, Table Of Contents, for details of that Section and it's Chapters.

WOW! Look what's new at Sega Pinball! Inside Front

- * Backbox Layout Locations: Fuses, Bridges, Relays & ROMs..... DR. ①
- * Find-It-In-Front: Dr. Pinball Section Explained..... DR. ②
- * Install 5-Balls * Diagnostic Aides * CPU DIP Switch Settings
* ROM Summary Table..... DR. ③
- * Switch Matrix Grid & Dedicated Switches * Lamp Matrix Grid..... DR. ④
- * Switch & Lamp Matrix Grid Locations * Typical Switch, Dedicated Switch
& Lamp Schematics..... DR. ⑤
- * Coils Detailed Chart Table..... DR. ⑥
- * Coil & Flash Lamp Locations * Typical Coil Wiring..... DR. ⑦
- * Domestic Pinball & Redemption Distributors DR. ⑧
- * International Distributors..... DR. ⑨
- * Power Requirements * Transportation * Game Dimensions..... DR. ⑩

Game Manual General Table of Contents i-ii

SECTION 1 1-2

- Chapter 1, Game Set-Up..... 1
 - Game Assembly Procedures..... 1
 - * How to Secure the Backbox for Transporting * Leg Leveler Adjustment
* Easy Access Service System - 3 Positions..... 2

SECTION 2 3-4

- Chapter 1, Game Operation & Features..... 3
 - * Start of Game Features * During Game Features * End of Game Features..... 3-4
 - * Instruction Card 4

SECTION 3 5-46

- Chapter 1, Portals™ Service Menu Introduction..... 5
 - Portals™ Service Menu Table of Contents (View for an outline of this section) 5
 - * Portals™ Service Menu Access & Use * How to Use This Section..... 6-7
 - Portals™ Service Menu Icon Tree 8-9
 - Portals™ Service Menu Example 10-11
- Chapter 2, Go To Diagnostics Menu..... 12-25
- Chapter 3, Go To Audits Menu..... 26-31
- Chapter 4, Go To Adjustments Menu..... 32-40
- Chapter 5, Go To Reset Menu..... 41-42
- Chapter 6, Go To Fuses List 43-44
- Chapter 7, Go To Help Screen 45-46

General Table of Contents Continued on the Next Page



January 1999



SECTION 4 47-78

Chapter 1, Parts Identification & Location (The Pink Pages) 47

Overview	47
Backbox (Showcase II) Assembly	48
Speaker Panel Assy. for the Backbox (Showcase II) & Associated Parts	49
Cabinet - General Parts	50
Cabinet & Playfield - Switches	51
Playfield - General Parts (Below) & Playfield - General Parts (Above)	52-53
Playfield - Rubber Parts (Rings Actual Size)	54
Playfield - Plastic (Butyrate), Decals and Mylar	55
Playfield - Rails and Ball Guides	56
Playfield - Metal Posts and Nuts (Actual Size)	57
Playfield - Metal Spacers (Actual Size)	58
Playfield - Plastic Posts and Spacers (Actual Size)	59
Playfield - Small Bayonet Type Bulbs and Sockets (Actual Size)	60
Playfield - Large Bayonet Type Bulb and Sockets (Actual Size)	61
Playfield - Wedge Base Bulbs and Sockets (Actual Size)	62

Chapter 2, Drawings for Major Assemblies & Ramps (The Blue Pages) 63

Overview	63
Ball Shooter (Plunger) Assembly, 500-6146-00-04	(Top) 64
Autoplunger Coil Assy., 500-6092-02 and Arm Weld Assy., 500-6091-00	(Bot) 64
5-Ball Trough Assembly, 500-6318-25 and A.P.: Ball Trough Enter/Exit Scoop	65
Flipper (Left) Assembly, 500-5944-14 and A.P.: Yellow Flipper Bat & Shaft Assy.	66
Flipper (Right) Assembly, 500-5944-04 and A.P.: Yellow Flipper Bat & Shaft Assy.	67
Turbo (Pop) Bumper Top Assy., 515-6459-01 (Qty. 3) and A.P.: Red Pop Cap (Qty. 3)	68
Turbo (Pop) Bumper Switch Assy., 515-6459-03 (Qty. 3)	68
Turbo (Pop) Bumper Bottom Assy., 515-6459-04 (Qty. 3)	68
Left & Right Slingshot Assemblies, 500-5849-00 (Qty. 2)	(Top) 69
VUK (Right Style) Assembly, 500-6290-01	(Bot) 69
Toilet & Frame Assembly, 500-6360-00-71	70-71
Toilet Lid Coil Assembly, 500-6392-00-71	70-71
Mr. Hankey & Tank Lid Lift Coil Assembly, 500-6391-00-71	70-71
Kenny Assembly, 500-6358-00-71	72-73
Super VUK Assembly, 500-6184-04-71	74
Under-Trough Assembly, 500-6385-00-71	(Top) 75
OPTO Assembly, 500-6242-02-71	(Bot) 75
Left Ramp Assembly, 500-6389-00-71	76
Right Ramp Assembly, 500-6383-00-71	77
UK ONLY OPTIONAL: Left & Right Outline Ball Deflector Assemblies, 500-5788-03 (Qty. 2)	(Top) 78
UK ONLY OPTIONAL: Up/Down Post Assembly, 500-6293-00	(Bot) 78

SECTION 5 79-110

➤ *Schematics & Troubleshooting Table of Contents (outline of this section) 79*

Chapter 1, Backbox Wiring (The Yellow Pages) 81-82

Chapter 2, Playfield Wiring (The Yellow Pages) 83-86

Chapter 3, Cabinet Wiring (The Yellow Pages) 87-88

Chapter 4, Printed Circuit Boards (PCBs) (The Yellow Pages) 89-110

APPENDIXES A-I 111-126

Appendixes A-I Table of Contents (outline of this section)	111
Appendixes A-I	112-124
Plastic Part Color Chart	(Bottom) 123 + (Top) 124
Glossary of Terms	125
Parts Order Checklist Notes	126

Limited Warranty, Cautions, Warnings & Notices Inside Back



Game Set-Up

Game Assembly Procedures

(Reference Find-It-In-Front: Dr. Pinball)

1. Open the top of the carton and lay it on its side with the bottom of the cabinet down. Using the plastic banding strip as a handle, slide the game out of the carton. **CAUTION: At least 2 people are required to move and maneuver game. Use proper moving equipment & extreme care while handling. Pinball game is 250 lbs.+.** Refer to DR. ① for Power Requirements, Transportation and Game Dimensions.
2. Remove all packing material. The four (4) Cabinet Leg Assemblies (Leg Levelers are attached) are in the corner packing material of the crate. A large Allen Wrench (use for securing the backbox) is inserted and taped to the rear of the cabinet. Leg Bolts, Steel Balls and any miscellaneous parts are in the cash box.
3. Support rear of cabinet and attach rear legs using two leg bolts for each leg. Support front of cabinet and attach front legs using two leg bolts for each leg.
4. While assuring that no cables are being pinched, carefully raise the backbox and secure it in its upright position with the Allen Wrench in the hole in the back of the cabinet and rotating the wrench 270° (¾ turn).
5. Remove the Coin Door Keys from the playfield glass, and open the Coin Door. Remove the Backbox Keys hanging inside the Coin Door, unlock the Backbox and open.
6. Check all connectors in the backbox for loose wire terminations. Reseat any loose wire by pushing in on the terminal. Push on all connectors plugged into the CPU/Sound Board, I/O Power Driver Board, and the Display Power Bd. to check that they are properly seated. Ensure Fluorescent Light Tube is seated correctly. Check that all fuses are seated properly. Close and lock the Backbox and secure its' keys back inside the Coin Door.
7. Remove the Front Molding & carefully remove the playfield glass and set it aside.
8. Remove all shipping tie downs, shipping blocks, packing foam, shipping instruction pages, etc. (if any) inside the cabinet. **READ ALL PRINTED INFORMATION!** Shipping instructions, labels and/or decals describe warnings, cautions, and/or important information specific to the game.
9. Raise the playfield and support it, by lifting the Prop Rod (located either on the left or right side, inside the cabinet) and placing the notched end into the hole on the under playfield. See the illustration "Easy Access Service System" opposite this page.
10. Visually inspect all cabinet cables and connector terminations; ensure no wires or cables are pinched and that cable harnesses are not pulled tight.
11. Remove the Plumb Bob tilt from the parts package and install on the pendulum wire on the inside left of the cabinet. Check the plumb tilt and adjust as required. See Section 4, Chapter 1, Parts Identification & Location.
12. Lower the playfield and ensure game is level side-to-side by adjusting Leg Levelers, if required. See the illustration "Leg Leveler Adjustment" opposite this page.
13. With the Leg Levelers turned all the way in (1.25" from floor to bottom of leg), the game pitch is 6.5°; depending on the condition of the floor, adjust the Leg Levelers as required.

The playfield incline affects difficulty of play. Use the recommended incline; Game difficulty is best varied using game adjustments.

14. If desired, perform any self tests at this time. See Section 3, Chapter 1, Portals™ Service Menu Introduction, and Chapter 2, Go To Diagnostics Menu, for instructions on how to enter "Begin Play Test" and "Game Specific" to test components on the game.
15. **INSTALL 5 BALLS** on the playfield near the outhole and carefully reinstall the playfield glass. (Amount of balls are always specified on decal attached to the lock down assembly.)
16. If desired, make Game Pricing (Standard and/or Custom) and Add-A-Ball, Novelty, or X-Ball Play adjustments at this time. See Section 3, Chapter 4, Go To Adjustments Menu, for instructions on how to enter adjustments. Follow instructions in the tables provided in the manual for suggestions of customizing changes.

Per  "The appliance has to be placed in a horizontal position."
"This appliance is not to be cleaned by a Water Jet."

How to Secure the Backbox for Transporting

Step 2.

Carefully pull the Backbox forward into the "down" position.

Step 1.

Unlock the Roto-Lock (Counter-Clockwise)

Step 3.

Ensure Cables do not bind, pinch or are being pulled tight. Hand-Feed out with Backbox so Cables are not tight.

The top of the Backbox will rest on the Pinball Side Armor. Strap or tie down the Backbox to keep from "bouncing" during transport.

Leg Leveler Adjustment

This cabinet is designed to automatically have a 6.5° pitch without any Leg Leveler adjustment!

Attach the four (4) Leg Assemblies to cabinet corners with the eight (8) leg bolts provided. See Section 4, Chapter 1, Cabinet - General Parts, for part numbers.

YOUR PLAYFIELD PITCH IS NOW AT 6.5° AS REQUIRED FOR PROPER GAME PLAY!

Verify 6.5° pitch. Minor adjustment(s) may be necessary depending on the location floor being level.

For custom adjustment greater than >6.5° can be achieved by turning out the rear leg leveler(s), however, it is not recommended.

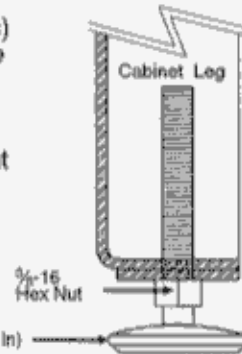

Easy Access Service System - 3 Positions

Carefully lift the playfield using the *Left and Right Ball Guides* upward.

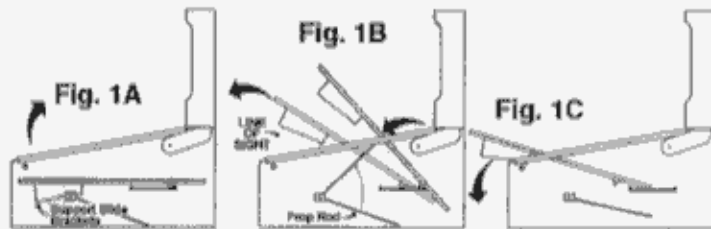

Positions 1 & 2

When lifted high enough, the *Playfield Support Slide Brackets* (Fig. 1A) can be seen & can clear the cabinet front. At this time, pull the playfield toward the front of the cabinet, checking that the mechanical components clear the cabinet front, then rest the playfield on the *Playfield Support Slide Brackets* at the front channel of cabinet (Fig. 1C); Or, the *Prop Rod* (located on the right inside of cabinet) can be used by positioning the *Prop Rod* end into the receiving playfield hole (Fig. 1B).

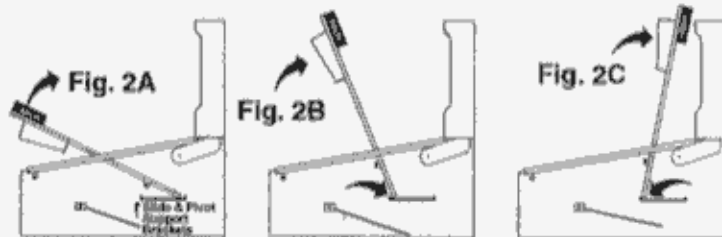

Position 3

With the playfield at rest, hold the sides & pull toward the front of the cabinet (approx. 6" to 8"), until resistance is felt from *Edge Slide Brackets* stopping against the *Slide & Pivot Support Brackets* located on either side of the cabinet (Fig. 2A). At this time, *swivel the playfield* toward the Backbox, then rest on the top edge (Fig. 2B & 2C).

See Section 4, Chapter 1, Backbox (Back Side/ Front Side) Assemblies, for part numbers.



Game Operation & Features

Start of Game Features

Starting a Normal Game

Insert coin(s). The game generates a sound for the first coin & for each subsequent coin with the display indicating the number of credits posted. Press the **START BUTTON** and a start-up sound is produced, and the posted credits are reduced by one. Subsequent players can be added (**up to 6 can play!**) by pressing the **START BUTTON** before the end of ball 1 (with sufficient credit in the game).

The display now indicates the player or # of players selected from the total depressions of the **START BUTTON**. The display indicates the ball in play, and a ball is served to the *Shooter Lane*. An introduction is shown followed by Skill Shot Graphics and/or instructions. Pressing the **START BUTTON** after ball 1 of any player will start a new game (if credits are available), **but only** if the **START BUTTON** is depressed for 2-3 seconds. This delay is to avoid accidental "re-starts" of a game. (Note: Any ½ credit remaining during game play after the end of ball 1, or power down, will be eliminated.)

Starting Team Play (Doubles!)

Team Play is a four player game. The totals for players 1 & 3 (Team 1) and players 2 & 4 (Team 2) are displayed individually as well as the combined score for both teams. Team Play only works in a 4-Player game. In all other cases, the individual scores are shown.

Starting League/Tournament Play

After credit is posted, while holding in the **LEFT FLIPPER BUTTON**, press the **START BUTTON**. League Play has now begun. The differences between Normal Game Play and League/Tournament Play are: There is no "auto-percentaging" (awarding extra balls, specials, etc. to players with very low scores on the second or third ball). Mystery Features are awarded in a set order rather than random in Normal Game Play. Percentage Game Features are not automatically advanced as they are for the Regular Play Features.

Starting Pinball Wizard Play

After credit is posted, while holding in the **RIGHT FLIPPER BUTTON**, press the **START BUTTON**. Pinball Wizard Play has now begun. The same as League/Tournament Play, but ooooooh! so much gosh darn harder!

During Game Features

Feature Mode & Combination Shots

Features are lit on the playfield and started by completing certain play shots (e.g. completion of target banks, orbit(s), ramp(s) and/or any combination of the shots). Combination shots (combos) are a series of shots completed in many different variations. For example, a shot to the Ramp with the ball being returned to the Left Inlane then immediately shot to the Orbit of the playfield returning to a Flipper and then shot to another Ramp would be a hard combo shot worthy of many points. These combinations vary per game. For feature modes & combos certain points or awards are given after completion.

Multiball

Multiball is started after completion of certain Feature Modes or may be a mode itself depending on game rules/play. Multiball may vary with the amount of balls used in Multiball depending on game style. Typically, if Multiball play was short, a "restart" option is given. Watch the Display for instructions on the restart.

Replay Feature

Replay awards are given as the player exceeds a High Score Level during game play. This can be adjusted with Adjustment 3, Replay Awards (Default=CREDIT, adjustable). Players exceeding the High Score Levels can receive: **CREDIT**, **EXTRA BALL**, or **SPECIAL**. Adjust to **NONE** if a replay award is not desired.

Video Mode

The video modes *may* require the player to "play on-screen". The interactive video play *may* require the player to use the flipper buttons to play the mode.

End of Game Features

Game Endings

When all player(s) have played all balls (including any Extra Balls), the game ends. If power is interrupted during the course of a game, it will end that game (*see Starting a Normal Game*). Closure of the Plumb Bob Tilt Switch according to the number of tilts set (Default = 2, adjustable) or its prolonged closure will end the current Ball-In-Play. Closure of the Slam Tilt Switch on the coin door ends the current game(s).

Match Feature

At the end of each ball, earned bonuses are collected. At the end of the last ball of a game (including any extra balls, if applicable), earned bonuses are collected, then the system produces a random 2-digit number (a multiple of 10; 00 to 90). Matching the last 2 digits of the player's score with this number awards a credit. In Adj. 11, Match Percentage (Default=7%, adjustable) can be changed from 0-10%. Changing the percentage to 0% displays the "Match Animation" at the end of the game, however, will never match (to award a credit). Changing this adjustment to **OFF** will not display the "Match Animation" nor award a credit.

Continued Next Page.



End of Game Features Continued

Entering Initials

If player achieved a new high score in any of the 3 categories (Regular, Novice or Wizard), the player may enter his/her initials. To enter your initials, use the Left & Right Flipper Buttons to choose letter or character as seen on the Dot Display. Hitting the Start Button locks in the letter or character and proceeds to the next letter. The game then proceeds into the *Game-Over Mode* and then to the *Attract Mode*. (Note: A custom message (adjustable) can be displayed during the *Attract Mode*; enter letters in the same fashion.)

Manual Percentaging

This game is equipped with a Manual Percentage Adjustment. As with our previous games, you can either set operator adjustments for a replay percent or you can set a fixed replay score. See Section 3, Chapter 4, Go To Adjustments Menu, Adjustments 1 & 2. If you set operator adjustments for a particular replay percent, the game will compute a recommended score to keep the game at that replay percentage. If a change is recommended and the game coin door is opened, the display will indicate if the replay is too high or low and make a sound to alert the operator. By pressing the Start Button, the score to beat will be changed to a more appropriate level. If you close the Coin Door or enter the **Portals™ Service Menu**, no score change will be made. You may choose to ignore the recommended change; for example, you may not think last week's players were the usual crowd. Just close the door and the message will disappear without altering the existing level. Or you may choose to make a different score to beat adjustment; this is done by utilizing Adj. 2, Replay Levels.

Instruction Card

Below is a **COPY** of the game instruction card which is included with every game. If your card is lost or damaged, simply **COPY** this page and **cut out** the Instruction Card as a *temporary replacement* until a *new card is ordered*. (**Suggestion: COPY & CUT** along the dotted line and fold in the center to keep the "COPY" sturdy.)

COPY &
CUT

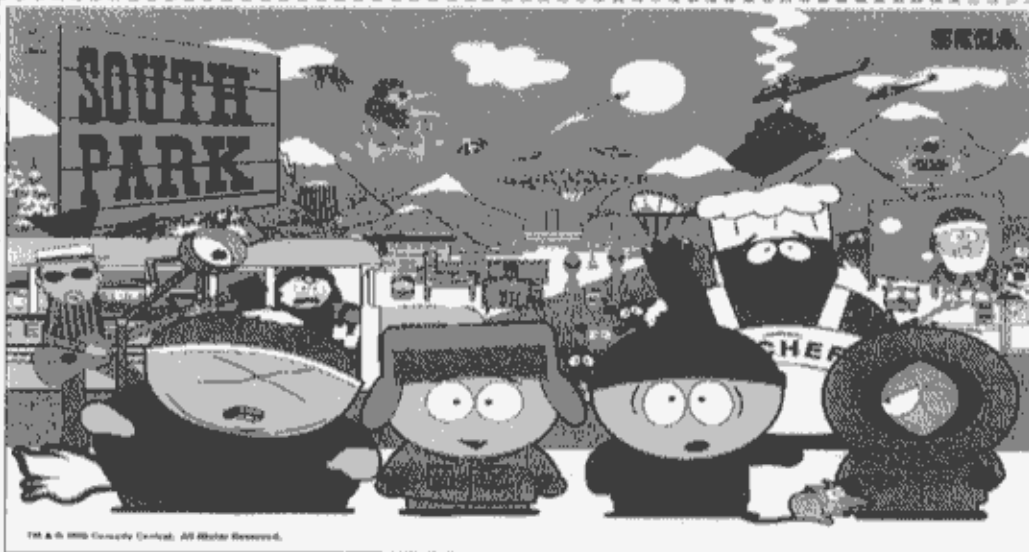

FOLD
HERE

SKILL SHOT Collect *Flashing Light* on the side *Targets* for points. Use *Flippers* to *change lights*.

MULTIBALL Shoot *Targets* below *Toilet* until completed. Then *shoot Ramp* to begin *Multiball*.

FEATURES Shoot a *Character* the indicated number of times to *START Feature*:

- ★ **STAN** Shoot **STAN** to collect *Jackpots*. Collect indicated *Jackpots* to "Complete."
- ★ **CHEF** Shoot *Flashing Shots* to collect awards. Complete all *Flashing Shots* to "Complete."
- ★ **KYLE** Shoot *Ramp* to "Complete."
- ★ **KENNY** Shoot **KENNY** to collect award and "Complete."
- ★ **CARTMAN** Shoot **CARTMAN** to collect award. Collect indicated awards to "Complete."

Note: If the face of a character is lit solid, then he has been completed.

If the face of a character is flashing, then he has been "Played but not completed."

SPOOKY VISION Playing all character's features, lights *CHEF Shot* for **SPOOKY VISION**. During *Spooky Vision*, completing all shots increases *Jackpot*.

VOLCANO Completing all character's features, lights *CHEF Shot* for **VOLCANO**. During *Volcano*, complete all characters (each shot three (3) times) to receive **WIZARD AWARD**.

EXTRA BALL *Mystery* or *Consolation* may light *Extra Ball*.

SPECIAL *Consolation* or *Features* may light *Special*.



Note to Beginners: To score better, shoot at the ((FLASHING SHOTS)) !!
Be sure to LOOK UP at the Dot Display for instructions when possible







Sega Pinball, Inc. TM & © 1999 South Park, Comedy Central TM & © 1998. All Rights Reserved.

Sega Part N° 755-5171-00



Portals™ Service Menu Introduction

Section 3
Table of Contents

Chapter 1, • INTRODUCTION		5
	Service Switch Set Access & Use / How to Use This Section.....	6-7
	Portals™ Service Menu Icon Tree	8-9
	Portals™ Service Menu Example and Exiting the Portals™ Service Menu.....	10-12
Chapter 2, • GO TO DIAGNOSTICS MENU		13
	•• Go To Switch Menu	14
	••• Switch Test / Active Switch Test / Dedicated Switch Test	14
	▣ Switch Matrix Grid & Dedicated Switches	14
	▣ Switch Matrix Grid Descriptions with Part Numbers and Locations.....	15
	•• Go To Coil Menu.....	16
	••• Single Coil Test / Cycling Coil Test	16
	▣ Coil & Flash Lamp Descriptions	16
	▣ Coil & Flash Lamp Locations.....	17
	▣ Coils Detailed Chart Table	18
	▣ Backbox I/O Power Driver Board Detailed Wiring Diagram.....	19
	•• Go To Lamp Menu	20
	••• Single Lamp Test / Test All Lamps / Row & Column Lamp Tests	20
	▣ Lamp Matrix Grid	20
	▣ Lamp Matrix Grid Locations.....	21
	•• Test Flash Lamps	22
	•• Clear Ball Trough	22
	•• Technician Alert.....	22
	•• Service Phone #.....	22
	•• Begin Play Test.....	22
	•• Fire Knocker	22
	•• Sound / Speaker Test.....	22
	▣ Speaker Phase Testing.....	23
	•• Begin Burn In.....	23
	•• Dot Matrix Test & Dot Matrix Display Explained.....	23
	•• South Park Specific (Mr. Hankey Test).....	24
	•• Dr. Pinball (Flow Chart Menus: Coil, Switch & Lamp).....	25
Chapter 3, • GO TO AUDITS MENU		27
	▣ Game Audit Table	26
	•• Earnings Audits (Audits 1-12).....	27
	•• Sega Audits (Audits 13-55).....	28-29
	•• South Park Audits (Audits 56-99).....	29-31
	•• Go To Printer Menu	31
	••• ...Printer Interface, ...Alison Interface, ...N ^o of Copies Printed (Adjustments).....	31
Chapter 4, • GO TO ADJUSTMENTS MENU		33
	▣ Game Adjustment Table	32
	•• Sega Adjustments (Adjustments 1-48).....	33-37
	•• South Park Adjustments (Adjustments 49+)	38
	•• Custom Message (Direct Access to Adjustment 34).....	40
	•• Film Star Reset (Special Factory Reset Settings for the Home Environment).....	40
Chapter 5, • GO TO RESET MENU		41
	•• Reset Coin Audits / Reset Game Audits / Factory Reset.....	41
	▣ Example.....	42
Chapter 6, • GO TO FUSES LIST		43
	•• Go To Fuses List	43
	▣ Example and Backbox Layout Locations: Fuses, Bridges, Relays & ROMs	43-44
Chapter 7, • Go To Help Screen		45
	•• Go To Help Screens (Multi-Level).....	45
	▣ Problem / Solution Table.....	46

Service Switch Set (Red, Green & Black Buttons) Access & Use

Open Coin Door and view Service Switch Set (see figures below). The Memory Protect Switch is now disabled; when changing adjustments, leave the coin door open, so changes can be made. **Important:** The **Playfield Power Interlock Switch** must be pulled out for electro-mechanical device testing (this is required).

① Entering Portals™ Service Menu (will not operate in Volume Mode):

Step 2
Move through the menus by pushing the Red "LEFT" or Green "RIGHT" Buttons.
Note: Pushing the Left or Right Flipper Buttons operates in the same way.

Step 1 (Black Button 1st)
Enter the Portals™ Service Menu by pushing the Black "BEGIN TEST" Button.

Step 3
Select or activate icons by pushing the Black "ENTER" Button.
Note: Pushing the Start Button operates in the same way.

IMPORTANT
Ensure the Playfield Power Interlock Switch (Located inside Coin Door Left) is pulled out. This is required for COIL and FLASH LAMP Testing.

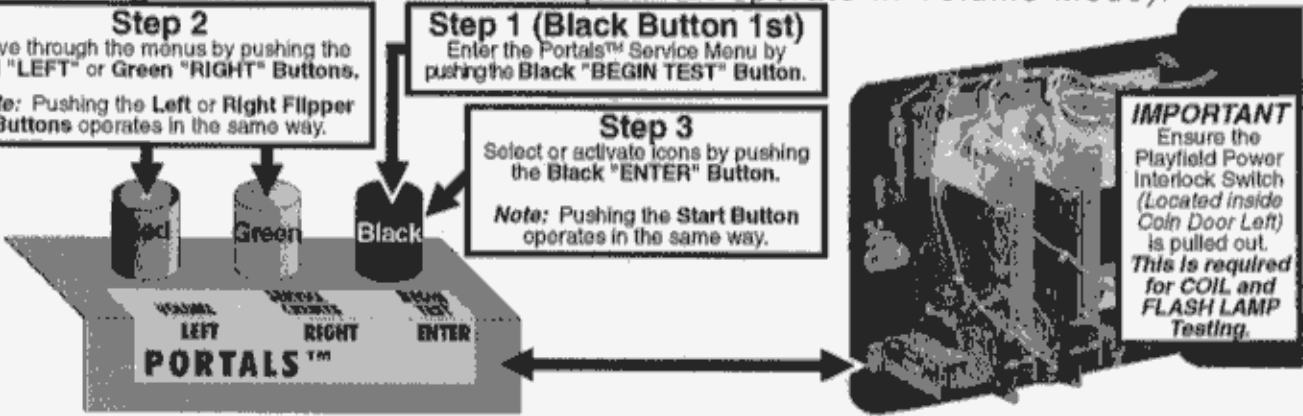

② Adding Service Credits (will not operate in Service or Volume Modes):

Step 1 (Green Button 1st)
Receive service credits by pushing the Green "SERVICE CREDITS" Button.

This button allows the technician to add Service Credits without adding any counts to the Coin Audits. Up to 30 credits can be applied.



LEFT FLIPPER BUTTON (Move Left) or (Decrease)

START BUTTON (Enter)

RIGHT FLIPPER BUTTON (Move Right) or (Increase)

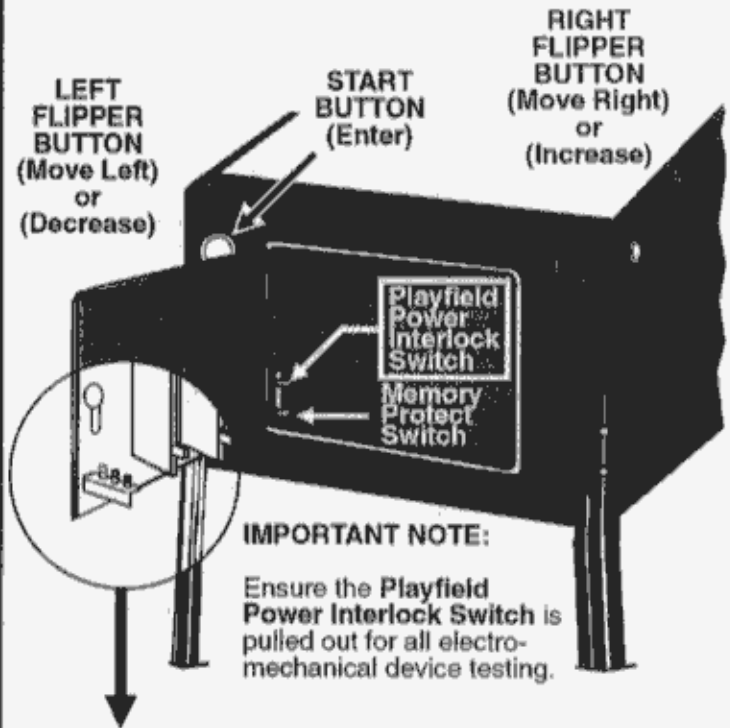

IMPORTANT NOTE:
Ensure the Playfield Power Interlock Switch is pulled out for all electro-mechanical device testing.

③ Entering the Volume Menu (will not operate in Service Mode):

Step 1 (Red Button 1st)
Enter the Volume Menu by pushing the Red "VOLUME" Button.



Step 2
* Decrease volume by pushing the Red "LEFT" Button.
* Increase volume by pushing the Green "RIGHT" Button.

Note: Pushing the Left or Right Flipper Buttons operates in the same way. Once adjustments are made, this menu will automatically exit in a few seconds.

-Red Button-
"Volume"
or
"Left"

-Green Button-
"Service Credits"
or
"Right"

-Black Button-
"Begin Test"
or
"Enter"

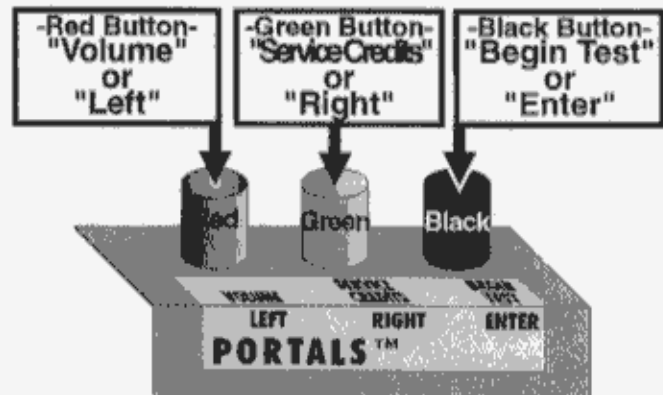

Section 3 | Icon Intro

Section 3 | Icon Intro



How to Use This Section

This section will cover all functions available in the **Portals™ Service Menu** in a *Step-By-Step* process. This section is divided into chapters which coincide with the **MAIN MENU**. The following pages in this chapter will instruct the operator on how to move through the menus. It's simple, easy and fun to use!

To get into the Service Menu Mode: • Power-up game (if not already) & open the Coin Door. • On the Coin Door is the Service Switch Set (**Red, Green & Black Buttons**). Push down the **Black "BEGIN TEST" Button**.

Looking at the Video Display you will momentarily see the introductory screen "**Service Menu**" with a *satellite flying from right to left pulling a banner "Portals™ ©"* followed by the **MAIN MENU**:



The Coin Door may be closed for security, however, please note with the Coin Door closed, the game's **MEMORY PROTECT** is enabled; *meaning any changes that are made will be not be written to memory*. If changing adjustments is required, ensure the Coin Door is open.

Use the **Red "LEFT" & Green "RIGHT" Buttons** (or **Left & Right Flipper Buttons**) to move the selected **ICON** left or right, and the **Black "ENTER" Button** (or **Start Button**) to activate the selected **ICON**. The use of the Service Switch Set (**Red, Green, & Black Buttons**) *is required* in Switch Test or Active Switch Test, as the **Start & Flipper Buttons** are a part of this test.

For diagnostic purposes, be sure the **Playfield Power Interlock Switch** is pulled out so **Playfield Power** is not disabled.

The **MAIN MENU** now appears with the "**DIAG**" *Icon* (**DIAGNOSTICS MENU**) flashing:



As the operator views the Menu Screen(s), the **MORE MORE** symbols indicates that there are more *Icons* to select in each direction. The *Icon* selected will blink. Pushing the **Black "ENTER" Button** (or **Start Button**) will select the *Icon* and the Menu Screen will change to the menu selected. Select the "**PREV**" *Icons* to move backwards through the menu levels. Select the "**QUIT**" *Icon* to completely exit the Service Mode.

View the **Portals™ Service Menu Icon Tree** on the next pages for a complete overview of all menus used in this system. View the last chapter (**HELP**) if more information is required. Selecting the "**QUIT**" *Icon* with the **Red "LEFT"** or **Green "RIGHT" Buttons** (or either **Flipper Button**), then pressing the **Black "ENTER" Button** (or **Start Button**) will exit the Service Mode. This applies to the large and small "**QUIT**" *Icons*.

The **chapters** in this section, which coincide with the **MAIN MENU**, will also provide more detailed information which could not fit in the display. Use both the manual and the display to help customize, troubleshoot and/or diagnose faults, if any.

Portals™ Service Menu Icon Tree for South Park

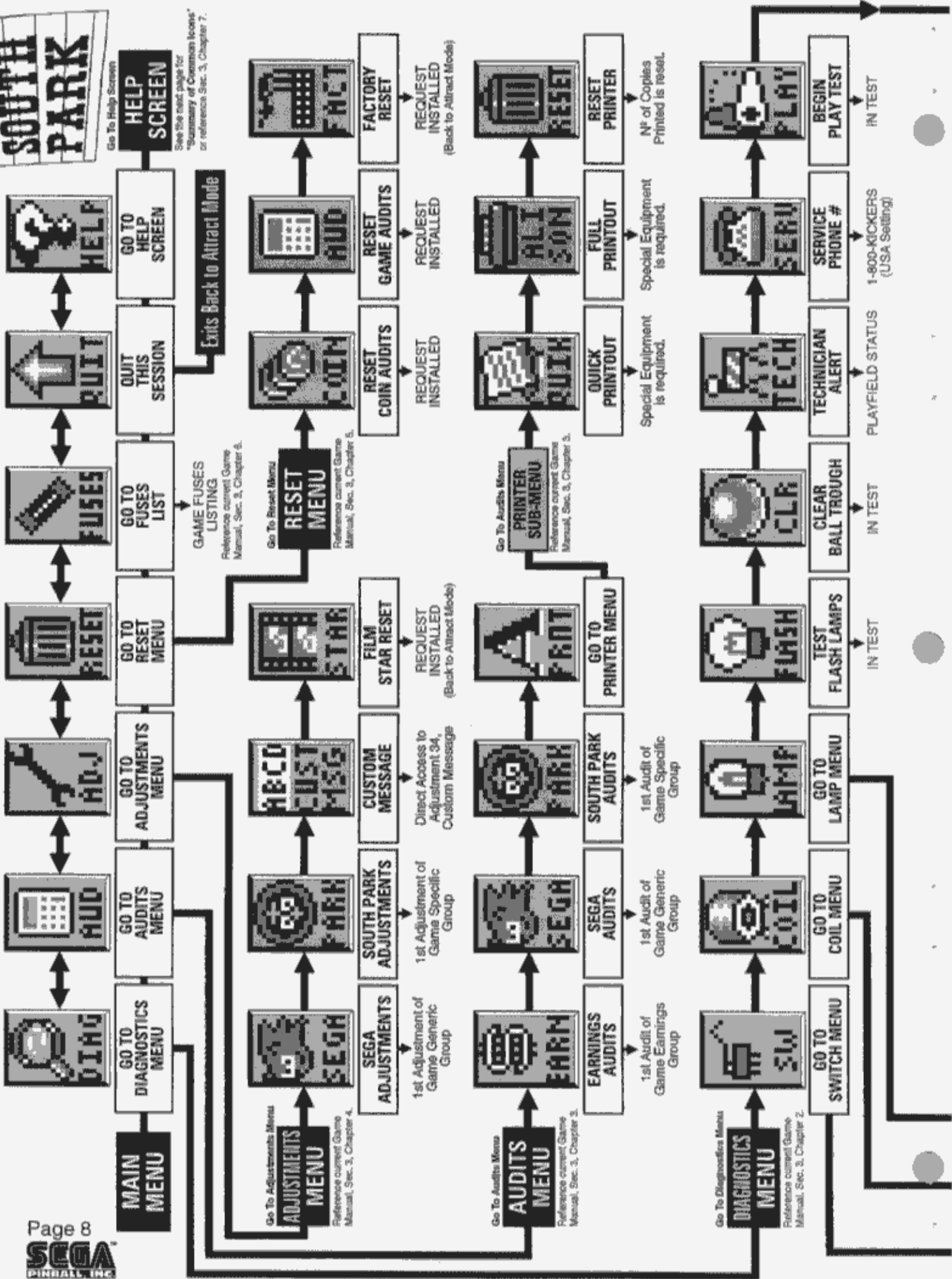

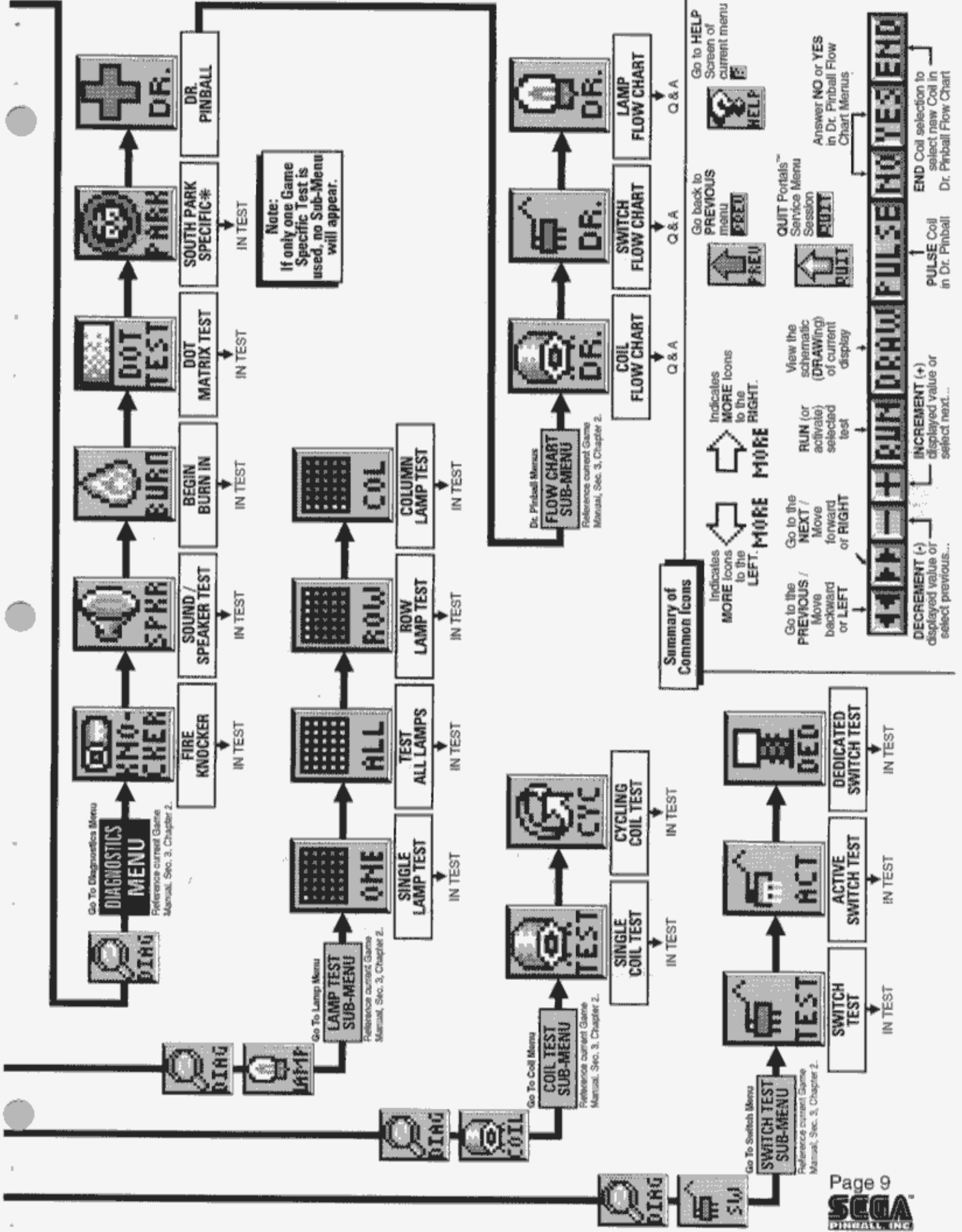

Note:
If only one Game Specific Test is used, no Sub-Menu will appear.

Summary of Common Icons

- Indicates MORE icons to the LEFT. MORE MORE
- Indicates MORE icons to the RIGHT. MORE MORE
- Go to the PREVIOUS / Move backward or LEFT
- Go to the NEXT / Move forward or RIGHT
- Go back to PREVIOUS menu
- Go to HELP Screen of current menu
- QUIT Portals™ Service Menu Session
- View the schematic (DRAWING) of current display
- Answer NO or YES in Dr. Pinball Flow Chart Menus
- END Coil selection to select new Coil in Dr. Pinball
- PULSE Coil in Dr. Pinball
- INCREMENT (+) displayed value or select previous...
- DECREMENT (-) displayed value or select next...

Portals™ Service Menu Example

This example will demonstrate activation of *Icons* in the **DIAGNOSTICS MENU**. The example will show activation of the "SW" *Icon* (GO TO SWITCH MENU). In this menu, the switches can be tested individually and also all active switches can be tested. Use the same technique to access all the *Icons* in the **Portals™ Service Menu**. Follow **Portals™ Service Menu Icon Tree** on the previous pages as a guide to help navigate through the entire system (Also, go to the chapter in this manual explaining the icon(s) selected.).

If the display is in any other menu other than the **MAIN MENU**, use the Red "LEFT" & Green "RIGHT" Buttons to select the "PREV" *Icon* and press the Black "ENTER" Button to activate the **ICON** thus moving back to the previous menu. Do so until **MAIN MENU** appears.

Chapters 2 through 7 will cover all menu items within the **Portals™ Service Menu**. The *Icon* is shown preceding the text. Find the *Icon* in the **Portals™ Service Menu** by navigating with the Red or Green Buttons. Each chapter started is from the **MAIN MENU**. Within the chapter, the sub-menu's will be covered sequentially with their explanation & function. If the operator "gets lost", select and activate the "PREV" *Icon* until the display indicates **MAIN MENU**. For more help, see Chapter 7.



MORE

The "MORE" symbols are indicating that "more icons" are available which don't appear in the display and which way to move the selection to view the *Icons*.



MORE

Important Note:



PREV

Exit any sub-menu and return to the **MAIN MENU** by selecting & activating the "PREV" *Icons*. If no *Icons* appear in the display because of a testing function or special display (e.g. Help, Schematic Display, etc.), press any service button to exit to the previous menu or sub-menu.



QUIT

Selecting & activating the "QUIT" *Icon* from any display will exit the Service Session.



HELP

Selecting & activating the "HELP" *Icon* will show a help screen. (An explanation of each Mini-*Icon* at that level will cycle continuously until any active button is pressed.)

Example: From the **MAIN MENU**, use the Red "LEFT" or Green "RIGHT" Buttons to select the "DIAG" *Icon* (GO TO DIAGNOSTICS MENU).



Press the Black "ENTER" Button to activate this **ICON**. This will bring up the **DIAGNOSTICS MENU**.

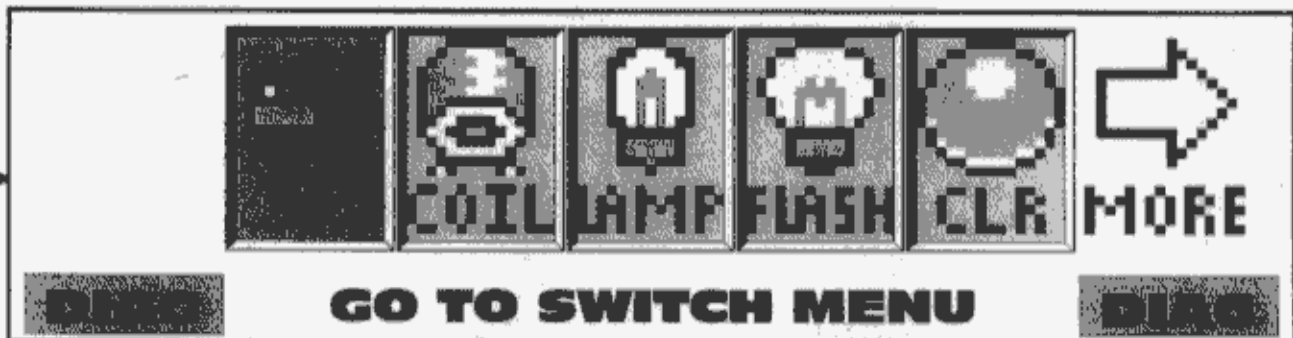

The **DIAGNOSTICS MENU** now appears with the "SW" *Icon* (GO TO SWITCH MENU) flashing. Press the Black Button to activate this icon. This will bring up the **SWITCH TEST MENU**.



The **SWITCH TEST MENU** now appears with the "TEST" *Icon* (SWITCH TEST) flashing:
 Press the **Black "ENTER" Button** to *activate* this icon. This will bring up the **Switch Test Display**.

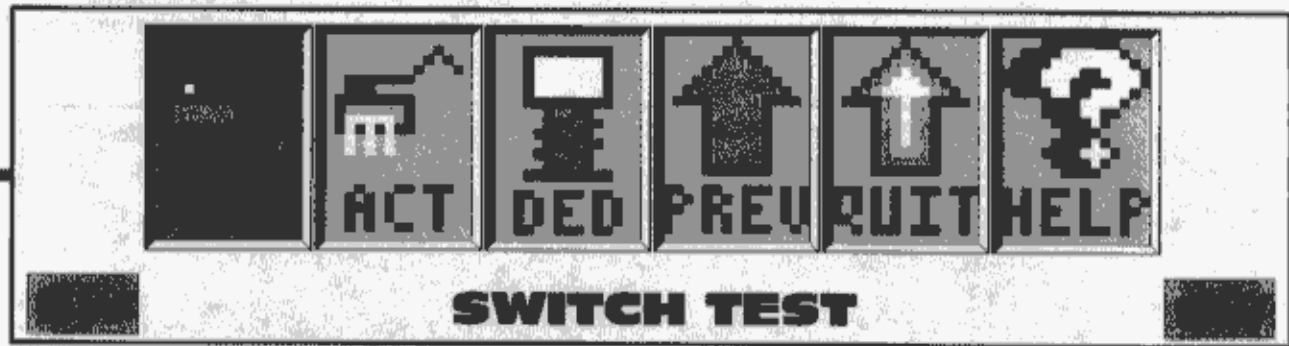

The **Switch Test Display** now appears.



All switches can be tested one at a time (When possible, use a pinball to close any playfield switches; rolling the ball at Stand-Up Targets or over/under switches is suggested. Use finger for all non-playfield switches.) As each switch is closed, the respective Switch Matrix Grid Position (1-64) will be lit. To view the schematic for the switch selected, press the **Red** or **Green Buttons** to select the "DRAW" *Icon*. Press the **Black Button** to *activate* this icon. This will bring up the **Switch Schematic Display** for the switch being closed.

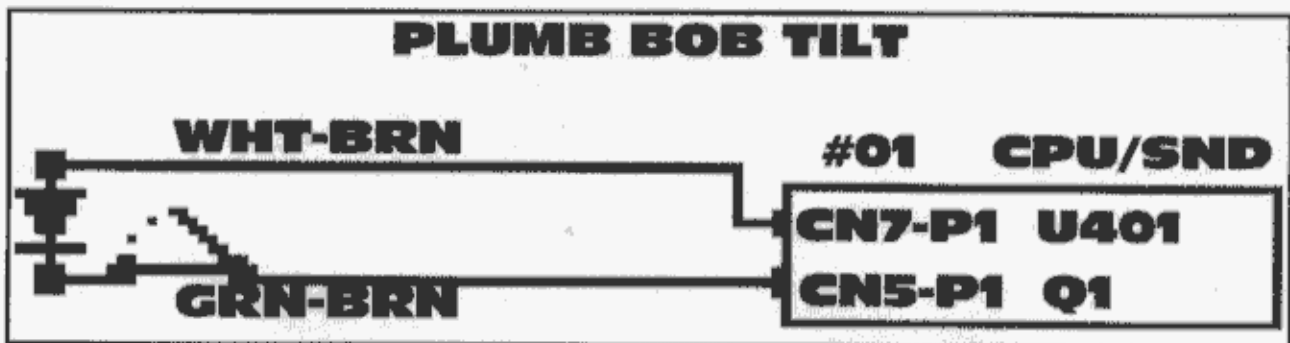

An example is shown with Switch #01, Plumb Bob Tilt, selected. The display describes the switch in the Switch Matrix which includes the name of the switch, the Return (Row) Wire and the Drive (Column) Wire, drive transistor, the part number (not shown in the above example) and the "Pin-Outs" from the CPU/Sound Board.

While in Switch or Active Switch Tests, the **Flipper & Start Buttons** are deactivated. Use the **Red "LEFT," Green "RIGHT"** and/or **Black "ENTER" Buttons** to select and activate the "MINI-ICONS" at the bottom of the display. In Switch Test, if the "Left Arrow" or "Right Arrow" *Icon* is activated, the display will go to the previous tests (Active and Dedicated Switch Tests). Use the **Red** or **Green Buttons** to change the selected **ICON** to "PREV" *Icon*. Press the **Black "ENTER" Button** to go to the previous menu.

Note:

In **Dedicated Switch Test**, the **Flipper & Start Buttons** are to be used instead of the **Red, Green & Black Service Buttons**, as these buttons are deactivated for this test.

Exit out of the sub-menu by activating the big "PREV" *Icon* in the menu. This will bring up the **DIAGNOSTICS MENU**. The Switch Test Session is now complete. See the next page about exiting the **Portals™ Service Menu**.

Exiting the Portals™ Service Menu

All *Icons* will be covered in the chapters of this section with the exception of the "QUIT" *Icon*, in the MAIN MENU. Both the large and small *Icons* if selected and activated, will exit the user from the Portals™ Service Menu. The display will return back to the ATTRACT MODE! To re-enter the Portals™ Service Menu follow the instructions at the beginning of this chapter.



If more help is required, see Chapter 7 of this section, and view the various help displays in the game.

Your Notes



Go To Diagnostics Menu

Special Note: If the *display flashes* "OPEN THE DOOR" the game is indicating that memory has been corrupted. This is caused by either failure in memory (e.g. batteries are dead and/or faulty RAM) or upon installation of updated version of game code. Opening the Coin Door will initiate a *Factory Restore*, by opening the *Memory Protect Switch*. Check battery voltage at **CMOS RAM** with the power off.

Overview

The **Portals™ Service Menu System** provides tests for sounds, display, lamps, switches and coils. Each feature may be tested manually or automatically after entering the **Portals™ Service Menu** (see Chapter 1 of this section). Select the "DIAG" *Icon* from the **MAIN MENU** to go to the **DIAGNOSTICS MENU**. The automatic tests (e.g. *Cycling Coils, Test Flash Lamps*) may be used for a quick verification of automatic test functions and the manual tests (*Begin Play Test, Single Lamp / All / Row / Column Tests, and Game Specific Test.*) may be used for troubleshooting. All *Icons* and their usages are explained throughout this chapter.

During game play, activation of switches and operation of coils with associated switches are monitored. If the **CPU/Sound Board** does not detect a switch transition ("Stuck Open" / "Stuck Closed") for 50 games, it is considered faulty. When operation of a coil should close or open a switch and does not, the coil is considered faulty. In the Attract Mode, faulty switches and coils (if any) are reported (Select the "TECH" *Icon, Technician Alert*, from the **DIAGNOSTICS MENU**). *Note that reporting of an unused switch does not constitute a problem and that a bad coil could mean that the associated switch requires adjustment.*

CAUTION: Remove pinballs from the Ball Trough prior to lifting the playfield for servicing. This can easily be done in the **Portals™ Service Menu System**. Select the "DIAG" *Icon* from the **MAIN MENU** to go to the **DIAGNOSTICS MENU**. Select the "CLR" *Icon* to enter the **CLEAR BALL TROUGH MENU**. Select the "RUN" *Icon* & press the **Start Button** to remove one ball at a time. This is also useful to retrieve one ball for game testing in *Begin Play Test & Game Specific Test*. **Important:** The **Power Interlock Switch** must be pulled out.



GO TO DIAGNOSTICS MENU

With the game in the Attract Mode, open the Coin Door and press the **Black "BEGIN TEST" Button**. Select the "DIAG" *Icon* in the **MAIN MENU** with either **Flipper** or **Red "LEFT" & Green "RIGHT" Buttons** (upon entry of the **Portals™ Service Menu**, the system defaults with the selection of the "DIAG" *Icon* flashing) and press the **Start** or **Black "ENTER" Buttons**. The **DIAGNOSTICS MENU** appears.



The "MORE" *symbols* are indicating that "more icons" are available which don't appear in the display and which way to move the selection to view the *Icons*.



Important Notes:



Exit any sub-menu and return to the **MAIN MENU** by selecting & activating the "PREV" *Icons*. If no *Icons* appear in the display because of a testing function or special display (e.g. "Help"), press any button to exit.



Selecting & activating the "HELP" *Icon* from any display will show a help screen. (An explanation of each *Mini-Icon* at that level will cycle continuously until any active button is pressed.)



Selecting & activating the "QUIT" *Icon* from any display will exit the Service Session.



In Diagnostics, selecting & activating the "-" or "+" *Icons* moves test forwards/backwards.



Selecting & activating the "RUN" *Icon* repeats the test on the coil or flash lamp left off at.



Selecting & activating the "ARROW" *Icons* moves between tests in the sub-menu.



Selecting & activating the "DRAW" *Icon* will show the schematic for that switch or coil.

Some tests require navigation through the menu(s) and selection of the *Icons* with **ONLY** the **Red "LEFT," Green "RIGHT" and Black "ENTER" Buttons**. This is required in *Switch & Active Switch Tests*, as the **Flipper & Start Buttons** are a part of the test.



In *Single Coil Test, Cycling Coil Test, Test Flash Lamps, Clear Ball Trough, Begin Play Test & South Park Specific Menu's*, the **Power Interlock Switch** (inside Coin Door) must be pulled out. (See *Access & Use* in Chapter 1 of this section for the location.)

If the **Power Interlock Switch** is not pulled out, all electro-mechanical devices (such as Coils) cannot be tested (20v & 50v DC power is disabled). Closing the Coin Door will automatically reset this switch.



Go To Switch Menu

From the **DIAGNOSTICS MENU**, select the "SW" *Icon* with either **Red "LEFT" or Green "RIGHT" Button** and press the **Black "ENTER" Button**. Switches are configured in an 8 x 8 Matrix of Columns (Switch Drives) and Rows (Switch Returns) with up to 64 switches possible. The Switch Test Menu consists of three (3) parts: Switch Test, Active Switches, and Dedicated Switch Test.

Note: The Flipper & Start Buttons are deactivated during Switch Tests.



Switch Test

To initiate, from the **SWITCH MENU**, select the "TEST" *Icon* with the **Red or Green Button** & press the **Black Button**. In Switch Test, close each switch and observe the display. The display will describe the switch in the Switch Matrix, which includes the switch name, Return (Row) Wire, Drive (Column) Wire, Part No, and the "Pin-Outs" from the CPU/SOUND Board. When the switch is released, the information of the last switch closed will remain in the display until another switch is closed or the test is exited. To view the switch schematic, select the "DRAW" *Mini-Icon* with the **Red or Green Button** & press the **Black Button**.



Active Switch Test

To initiate, from the **SWITCH MENU**, select the "ACT" *Icon* with either **Red or Green Button** & press the **Black Button**. If still in a previous test, select the "PREV" *Icon* to return to Switch Menu or selecting either of the "ARROW" *Icons* will move through the tests. If any switches are stuck closed (or made from the presence of a pinball), the display sequences through the Switch Names, Return (Row) Wire, Drive (Column) Wire, Drive Transistor, Part No, and the "Pin-Outs" from the CPU/SOUND Board. This cycle continues until all switches are cleared or until the test is exited.



Dedicated Switch Test

To initiate, from the **SWITCH MENU**, select the "DED" *Icon* with either **Flipper Button** & press the **Start Button** (The service switches are deactivated during this test.). The display will describe the switch which includes the Switch Name, Return (Row) Wire, Drive (Column) Wire, Part No, and the "Pin-Outs" from the CPU/SOUND Board.

SWITCH MATRIX GRID & DEDICATED SWITCHES

Diodo O n T ermin al S trip		SWITCH MATRIX GRID & DEDICATED SWITCHES								GRND	
Column (Drive)	Row (Return)	1: Q1	2: Q2	3: Q3	4: Q4	5: Q5	6: Q6	7: Q7	8: Q8	IC U206 INPUTS	Ground
		GRN-BRN C N5-P1	GRN-RED C N5-P3	GRN-ORG C N5-P4	GRN-YEL C N5-P5	GRN-BLK C N5-P6	GRN-BLU C N5-P7	GRN-VIO C N5-P8	GRN-GRY C N5-P9		BLK C N6-P1, -P11
1: U400	WHT-BRN C N7-P9	LEFT BUTTON (UK ONLY) (On Cabinet side)	NOT USED	LEFT 3-BANK BOTTOM (Under PIP)	RIGHT RAMP ENTER (Above PIP)	NOT USED	NOT USED	LEFT TURBO BUMPER (Under PIP)	LEFT OUTLANE (Under PIP)	1: U206	#1 LEFT FLIPPER BUTTON (On Cabinet side)
2: U400	WHT-RED C N7-P8	4TH COIN SLOT (On Coin Door)	5-BALL TROUGH #1 (LEFT) (Under PIP)	LEFT 5-BANK #2 (Under PIP)	RIGHT RAMP EXIT (Above PIP)	RIGHT 3-BANK BOTTOM (Under PIP)	KENNY OPTO (Under PIP)	RIGHT TURBO BUMPER (Under PIP)	LEFT RETURN LANE (Under PIP)	2: U206	#2 LEFT FLIPPER E.O.S (End-of-Stroke) (On Cabinet side)
3: U400	WHT-ORG C N7-P7	6TH COIN SLOT (On Coin Door)	5-BALL TROUGH #2 (Under PIP)	LEFT 5-BANK #3 (Under PIP)	NOT USED	RIGHT 3-BANK MIDDLE (Under PIP)	UNDER-TROUGH (TOILET) (Under PIP)	BOTTOM TURBO BUMPER (Under PIP)	LEFT SLINGSHOT (Under PIP)	3: U206	#3 RIGHT FLIPPER BUTTON (On Cabinet side)
4: U400	WHT-YEL C N7-P6	RIGHT COIN SLOT (On Coin Door)	5-BALL TROUGH #3 (Under PIP)	LEFT 5-BANK #4 (Under PIP)	NOT USED	RIGHT 3-BANK TOP (Under PIP)	UNDER-TROUGH (KENNY) (Under PIP)	NOT USED	RIGHT OUTLANE (Under PIP)	4: U206	#4 RIGHT FLIPPER E.O.S. (End-of-Stroke) (On Cabinet side)
5: U401	WHT-GRN C N7-P5	CENTER COIN SLOT /DBA (On Coin Door)	5-BALL TROUGH #4 (Under PIP)	LEFT 5-BANK TOP (Under PIP)	NOT USED	POP BUMPER TARGET LT (Under PIP)	SVUK (Under PIP)	NOT USED	RIGHT RETURN LANE (Under PIP)	5: U206	NOT USED
6: U401	WHT-BLU C N7-P3	LEFT COIN SLOT (On Coin Door)	5-BALL TROUGH VUK OPTO (Under PIP)	CENTER 3-BANK LEFT (Under PIP)	NOT USED	POP BUMPER TARGET RT (Under PIP)	VUK (Under PIP)	START BUTTON (Cabinet Front)	RIGHT SLINGSHOT (Under PIP)	6: U206	#5 VOLUME (RED BUTTON) (In Test: LEFT) (On Coin Door)
7: U401	WHT-VIO C N7-P2	5TH COIN SLOT (On Coin Door)	5-BALL STACKING OPTO (Under PIP)	CENTER 3-BANK MIDDLE (Under PIP)	NOT USED	LEFT ORBIT (TO VUK) (Under PIP)	SLAM TILT (On Coin Door)	NOT USED	NOT USED	7: U206	#7 SERM. CRED. (GREEN BUTTON) (In Test: RIGHT) (On Coin Door)
8: U401	WHT-GRY C N7-P1	RIGHT BUTTON (UK ONLY) (On Cabinet side)	SHOOTER LANE (Under PIP)	CENTER 3-BANK RIGHT (Under PIP)	NOT USED	UNDER-TROUGH SVUK (Under PIP)	PLUMB BOB TILT (On Coin Door)	NOT USED	NOT USED	8: U206	#8 BEGIN TEST (BLACK BUTTON) (In Test: ENTER) (On Coin Door)

Typical Switch Schematic & Wiring

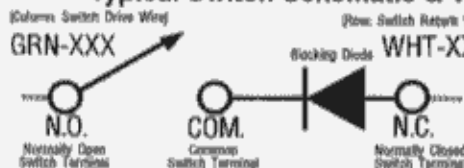

Note:
All switches require diodes. Some diodes are located on Terminal Strips (under playfield) & not on the switch itself.
Diodo O n T ermin al S trip



Dedicated Switch Schem.

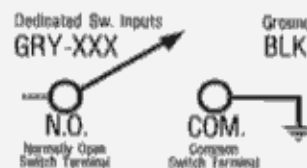

Switch Matrix Grid Descriptions with Part Numbers and Locations

The Switch locations correspond with the Switch N^o in the Part Number Table shown & the Switch Matrix Grid (previous page).

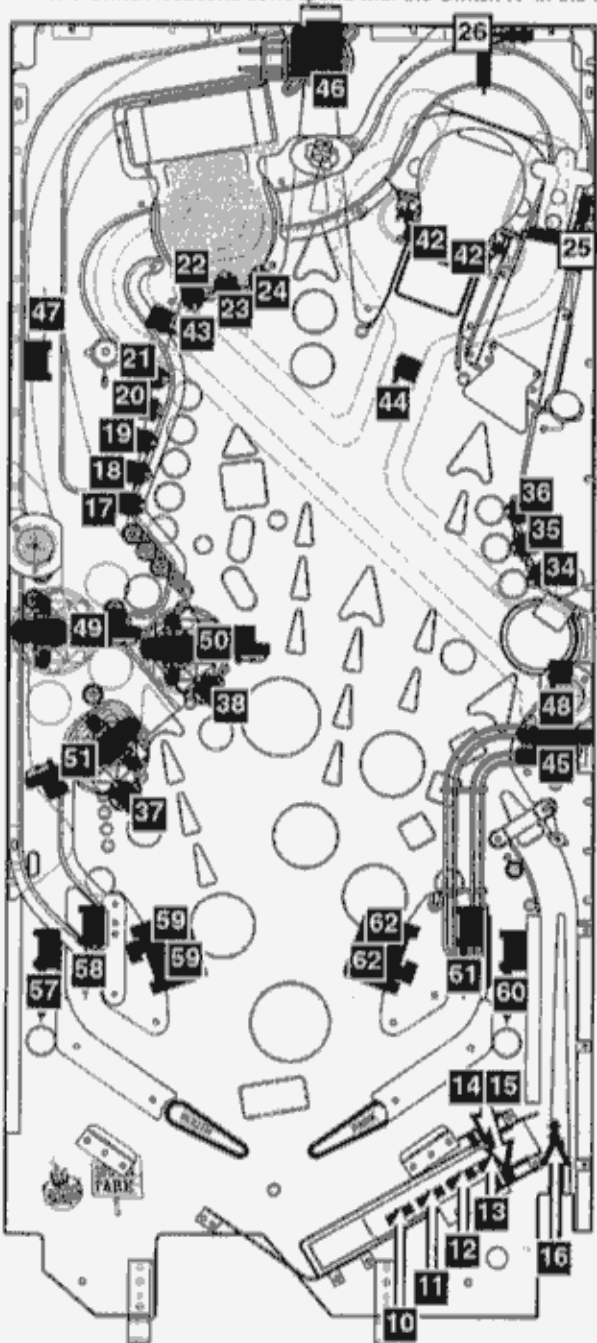

Sw. N ^o	Col. N ^o	Row N ^o	Sw. Matrix	Switch Matrix Description	Part N ^o
Note: The ¥ Coin Switch (for Japan) is 180-5091-00					
1	1	1		LT BUTTON (UK ONLY)	180-5180-00
2*	1	2		4TH COIN SLOT	180-5024-00
3*	1	3		6TH COIN SLOT	(Future Use)
4*	1	4		RIGHT COIN SLOT	
5*	1	5		CENTER COIN SLOT / DBA	180-5024-00
6*	1	6		LEFT COIN SLOT	
7*	1	7		5TH COIN SLOT	(Future Use)
8	1	8		RT BUTTON (UK ONLY)	180-5180-00
9	2	1		NOT USED	
10	2	2		5-BALL TROUGH #1 (LEFT)	
11	2	3		5-BALL TROUGH #2	180-5119-02
12	2	4		5-BALL TROUGH #3	
13	2	5		5-BALL TROUGH #4	
14	2	6	‡	5-BALL TROUGH BOT TRANS: VUK OPTO	520-5173-00 520-5174-00
15	2	7	‡	5-BALL STACKING OPTO TOP REC:	520-5173-00 520-5174-00
16	2	8		SHOOTER LANE	180-5157-00
17	3	1	R	LEFT 5-BANK BOT. (Purp. Sq. Rear Mnt.)	
18	3	2	R	LEFT 5-BANK #2 (Purple Sq. Rear Mnt.)	
19	3	3	R	LEFT 5-BANK #3 (Purple Sq. Rear Mnt.)	500-6139-09R
20	3	4	R	LEFT 5-BANK #4 (Purple Sq. Rear Mnt.)	
21	3	5	R	LEFT 5-BANK TOP (Purp. Sq. Rear Mnt.)	
22	3	6	R	CENTER 3-BANK LT. (Grn. Nar. Rear Mnt.)	500-6138-04R
23	3	7		CENTER 3-BANK MID. (Red Rect. Fwd.)	500-6228-02
24	3	8		CENTER 3-BANK RT. (Grn. Narrow Fwd.)	500-6138-04
25	4	1		RIGHT RAMP ENTER	
26	4	2		RIGHT RAMP EXIT	180-5087-00
27	4	3			
28	4	4			
29	4	5		NOT USED	
30	4	6			
31	4	7			
32	4	8			
33	5	1			
34	5	2	R	RT 3-BANK BOT. (Flo. Grn. Rnd. Rear Mnt.)	
35	5	3	R	RT 3-BANK MID. (Flo. Grn. Rnd. Rear Mnt.)	500-6075-11R
36	5	4	R	RT 3-BANK TOP. (Flo. Grn. Round Rear Mnt.)	
37	5	5		POP BUMPER TARGT LT. (Flo. Grn. Sq.)	
38	5	6		POP BUMPER TARGT RT. (Flo. Grn. Sq.)	500-6139-11
39	5	7			
40	5	8		NOT USED	
41	6	1			
42	6	2		KENNY (OPTO) TRANS REC	520-5082-00 520-5083-01
43	6	3		UNDERTROUGH (TOILET)	
44	6	4		UNDERTROUGH (KENNY)	180-5057-00
45	6	5	8203	SVUK (Super Vertical Up-Kicker Switch)	180-5052-00
46	6	6	8203	VUK (Vertical Up-Kicker Switch)	180-5116-01
47	6	7		LEFT ORBIT (TO VUK)	500-6227-02
48	6	8		UNDERTROUGH SVUK	180-5057-00
49	7	1		LEFT TURBO BUMPER	
50	7	2		RIGHT TURBO BUMPER	180-6015-03
51	7	3		BOTTOM TURBO BUMPER	
52	7	4			
53	7	5		NOT USED	
54*	7	6		START BUTTON (Red)	500-6090-02
55*	7	7		SLAM TILT (On Coin Door)	180-5022-00
56*	7	8		PLUMB BOB TILT HANGER CONTACT	535-6319-00 535-7563-01
57	8	1		LEFT OUTLANE (Rt. Mount R/O)	
58	8	2		LEFT RETURN LANE (Rt. Mnt. R/O)	500-6227-02
59	8	3		LEFT SLINGSHOT (Double-Switch)	180-5054-00
60	8	4		RIGHT OUTLANE (Rt. Mount R/O)	
61	8	5		RIGHT RETURN LANE	500-6227-02
62	8	6		RIGHT SLINGSHOT (Double-Switch)	180-5054-00
63	8	7			
64	8	8		NOT USED	

‡ Sw. 14 / Sw. 15 have both REC/TRANS on 1 board respectively.
 * R : The 'R' following the Part Number on Stand-Up Targets means reverse (rear) mounted Target & Switch Actuator.
 DOTS: Diode On Terminal Strip, if noted.

Legend Note:

- = Switches mounted above playfield.
- = Switches mounted below playfield.

* The following switches are located in the cabinet and are not noted in the diagram above:

2 4 5 6 54 55 56

The following switches are not used:

9 27-33 39-41 52-53 63-64

Switches for UK only: **1 + 8**

Section 3 | Diags.





Go To Coil Menu

From the **DIAGNOSTICS MENU**, select the "COIL" *Icon* with either **Red "LEFT"** or **Green "RIGHT" Button** and press the **Black "ENTER" Button**. The coils are listed in groups. Coils 01-16 are typically High Current Coils (although Low Current Coils may be used in positions 01-07). Coils 17-24 are typically Low Current Coils. The remaining positions (F1-F8) are typically for Flash Lamps (although they may be used any positions 01-24, read **Single Coil Test**). **Important:** The **Power Interlock Switch** must be pulled out.



Single Coil Test

To initiate, from the **COIL MENU**, select the "TEST" *Icon* with either **Red** or **Green Button** and press the **Black Button**. Ensure the **Power Interlock Switch** is pulled out. Select either the "-" or "+" *Icons*. Start with the "+" *Icon* to start the manual Coil Test from #1 (The test runs through Coils 1-24 and Flash Lamps F1-F8; *Note: Some Flash Lamps are used in Coil Positions; this game: #7 & #18*). Press the **Black Button** on the "+" *Icon*, as each coil is selected, the display will describe the Coil or Flash Lamp Name with the corresponding number, the wire with colors, the "Pin-Outs" from the I/O Power Driver Board, the Coil Voltage & Gauge-Turns (e.g. 23-800). Press the **Black Button** again to move forward in the test. To test and view a particular Coil or Flash Lamp, select the "RUN" *Icon* and press the **Black Button**. Each time the **Black Button** is pushed, the Coil or Flash Lamp will fire on the Playfield and/or Backbox, with the display indicating the Coil or Flash Lamp information. Continue with the same procedure to run through the entire test.

Important: The **Power Interlock Switch** must be pulled out.



Cycling Coil Test

To initiate, from the **COIL MENU**, select the "CYC" *Icon* with either **Red** or **Green Button** and press the **Black Button**. If still in a previous test, select the "PREV" *Icon* to return to Coil Menu or selecting either of the "ARROW" *Icons* will move to Cycling Coil Test (selecting again will return to Coil Test). The test pulses each regular Coil or Flash Lamp sequentially (cycling) on the Playfield and Backbox. The display indicates "CYCLING COILS." **Important:** The **Power Interlock Switch** must be pulled out.

Coil & Flash Lamp Descriptions

Type	Coil / Flash Lamp Descriptions
COIL 1	TROUGH UP-KICKER (VUK) (26-1200)
COIL 2	AUTO LAUNCH (50V) (24-940)
COIL 3	SUPER VUK (24-940)
COIL 4	TOP VUK (26-1200)
COIL 5	TOILET SEAT LID (23-1100)
COIL 6	MR. HANKEY LATCH (29-1000)
COIL 7	FLASH POPS *4
COIL 8	(EUROPEAN TOKEN DISPENSER)
COIL 9	LEFT TURBO BUMPER (26-1200)
COIL 10	RIGHT TURBO BUMPER (26-1200)
COIL 11	BOTTOM TURBO BUMPER (26-1200)
COIL 12	LEFT SLINGSHOT (23-800)
COIL 13	MR. HANKEY (DOWN) (23-1100)
COIL 14	KENNY PIVOT (DEAD) (22-1080)
COIL 15	LEFT FLIPPER [50V RED/YEL] (23-1100)
COIL 16	RIGHT FLIPPER [50V RED/YEL] (23-1100)

Type	Coil / Flash Lamp Descriptions
COIL 17	RIGHT SLINGSHOT (23-800)
COIL 18	FLASH TOP VUK *1
COIL 19	KENNY LT (24-940)
COIL 20	KENNY RT (24-940)
COIL 21	LT OUTLANE (UK ONLY) (28-1050)
COIL 22	RT OUTLANE (UK ONLY) (28-1050)
COIL 23	UP/DOWN POST (UK ONLY) (23-1100)
COIL 24	(OPTIONAL COIN METER)
#F1	FLASH STAN *2 (#89 Bulb)
#F2	FLASH CHEF *2 (#89 Bulb)
#F3	FLASH KENNY *2 (#89 Bulb)
#F4	FLASH KYLE *2 (#89 Bulb)
#F5	FLASH CARTMAN *2 (#89 Bulb)
#F6	FLASH KENNY *1 BACK *2 (#906 (1) #89 (2))
#F7	FLASH MR HANKEY/TOILET *2 (#89 Bulb)
#F8	FLASH SUPER VUK *1 (#89 Bulb)

See the next three (3) pages for the **Coil & Flash Lamp Location Maps** (corresponds to above tables), **Coils Detailed Chart Table** & the **Backbox I/O Power Driver Board Detailed Wiring Diagram**.

Typical Coil Wiring

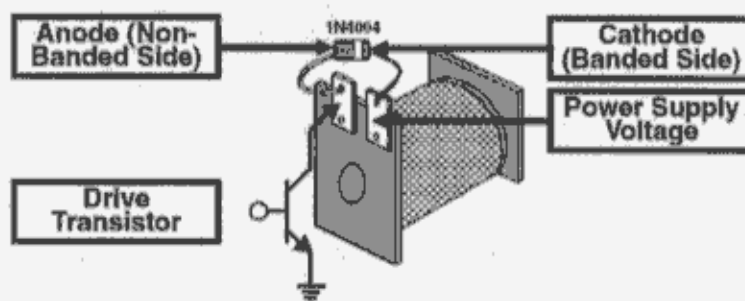

Note:
All Coils require diodes. Some diodes are located on Terminal Strips (under playfield) & not on the coil itself.

D iode
O n
T ermin
S trip



Coil & Flash Lamp Locations

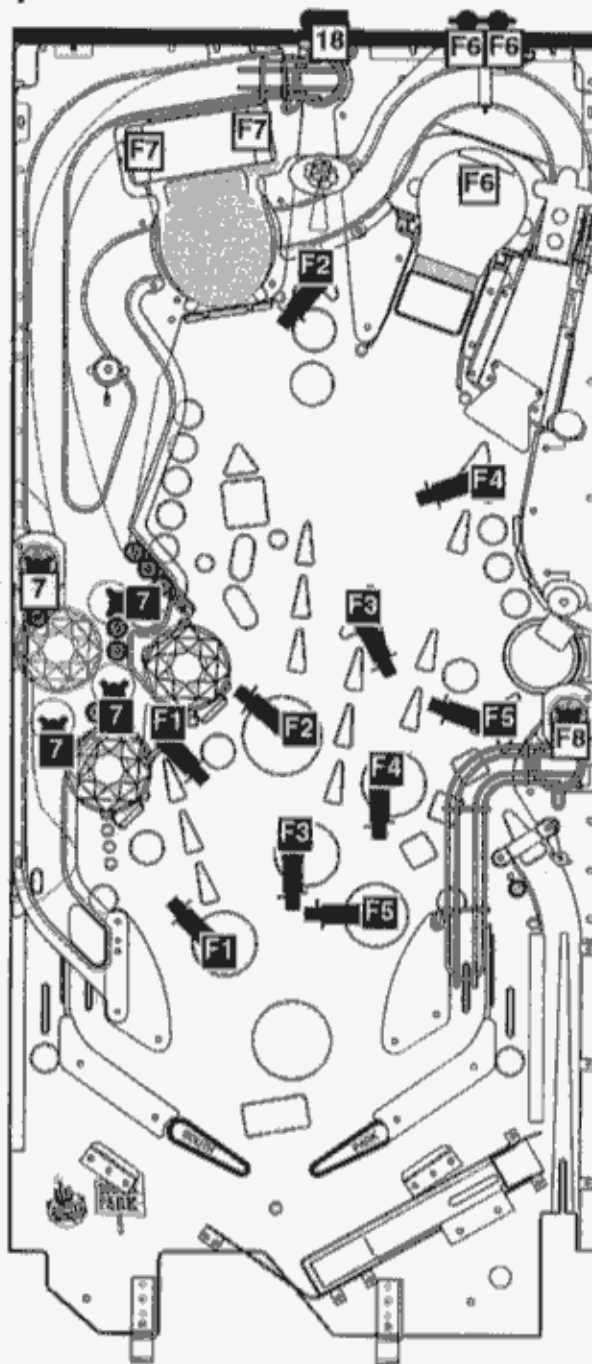
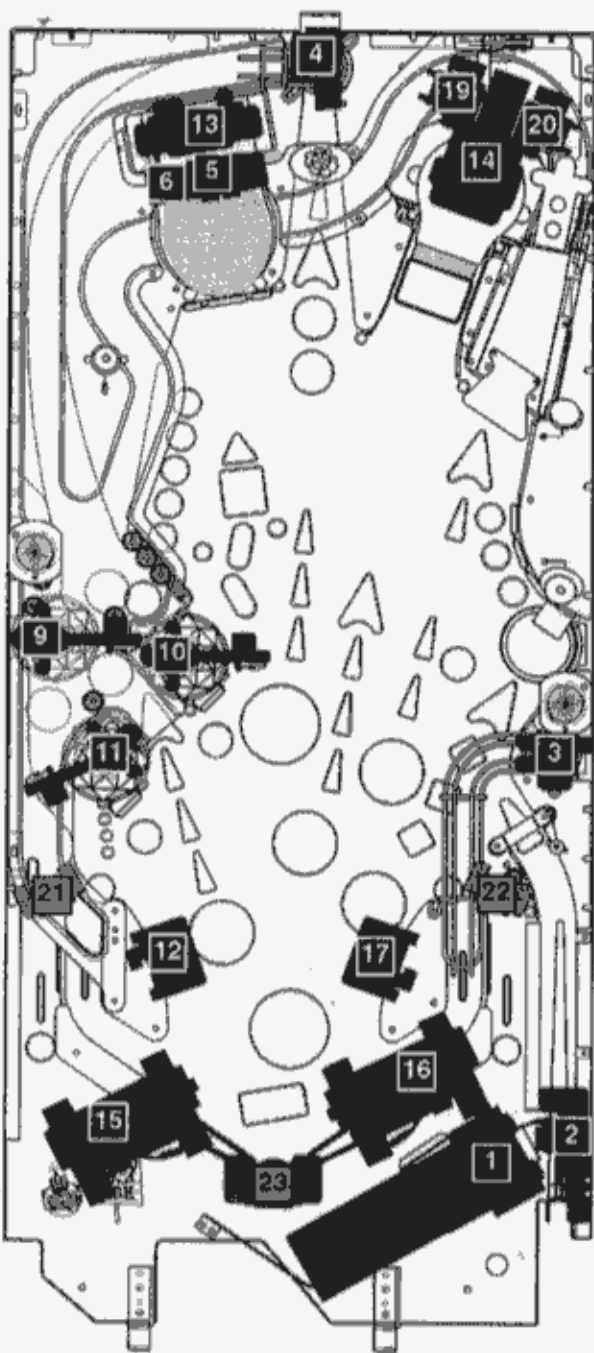

Section 3 | Diags.

Use the previous page and the following two (2) pages in conjunction with above Coil and Flash Lamp Maps.

Legend Note:

- = Coils and Flash Lamps mounted above playfield.
- = Coils and Flash Lamps mounted below playfield.

The following Bulb Type is used for Flash Lamps:

The following Coils are optional for UK Only:

- 21
- 22
- 23

The following Coils are Optional:

- 08
- 24



#89 Bulb
(Bayonet)
165-5000-00



#906 Bulb
(Wedge Base)
165-5004-00





From the Main Menu
in Portals
GO TO DIAGNOSTICS
MENU



From the Diagnostics
Menu
GO TO COIL
MENU



From the Coil
Menu
GO TO COIL
TEST



From the Coil
Menu
GO TO CYCLING
COILS

COILS DETAILED CHART TABLE

High Current Coils Group 1		Drive Transistor (D.T.)	Driver Output Board	D.T. Control Line Color	D.T. Control Line Connect	Power Line Color	Power Line Connection	Power Voltage	Coil GA/Turn or Bulb Type
#1	TROUGH UP-KICKER	Q1	I/O Pwr. Drvr.	BRN-BLK	J8-P1	YEL-VIO	J10-P4/5	50v DC	26-1200 090-8044-00T
#2	AUTO LAUNCH	Q2	I/O Pwr. Drvr.	BRN-RED	J8-P3	YEL-VIO	J10-P4/5	50v DC	24-940 090-8038-00T
#3	SUPER VUK	Q3	I/O Pwr. Drvr.	BRN-ORG	J8-P4	YEL-VIO	J10-P4/5	50v DC	24-940 090-8038-00T
#4	TOP VUK	Q4	I/O Pwr. Drvr.	BRY-YEL	J8-P5	YEL-VIO	J10-P4/5	50v DC	26-1200 090-8044-00T
#5	TOILET SEAT LID	Q5	I/O Pwr. Drvr.	BRN-GRN	J8-P6	BRN	J7-P1	20v DC	23-1100 090-8030-00T
#6	MR. HANKEY LATCH	Q6	I/O Pwr. Drvr.	BRN-BLU	J8-P7	YEL-VIO	J10-P4/5	50v DC	29-1000 090-8059-00
#7	FLASH POPS *4	Q7	I/O Pwr. Drvr.	BRN-VIO	J8-P8	ORG	J6-P10	20v DC	#89 Bulb 165-5000-89
#8	EUROPEAN TOKEN DISPENSER	Q8	I/O Pwr. Drvr.	BRN-GRY	J8-P9	YEL-VIO	J10-P4/5	50v DC	DL4SS 115-8078-01
High Current Coils Group 2		Drive Transistor (D.T.)	Driver Output Board	D.T. Control Line Color	D.T. Control Line Connect	Power Line Color	Power Line Connection	Power Voltage	Coil GA/Turn
#9	LEFT TURBO BUMPER	Q9	I/O Pwr. Drvr.	BLU-BRN	J9-P1	YEL-VIO	J10-P4/5	50v DC	26-1200 090-8044-00T
#10	RIGHT TURBO BUMPER	Q10	I/O Pwr. Drvr.	BLU-RED	J9-P2	YEL-VIO	J10-P4/5	50v DC	26-1200 090-8044-00T
#11	BOTTOM TURBO BUMPER	Q11	I/O Pwr. Drvr.	BLU-ORG	J9-P4	YEL-VIO	J10-P4/5	50v DC	26-1200 090-8044-00T
#12	LEFT SLINGSHOT	Q12	I/O Pwr. Drvr.	BLU-YEL	J9-P5	BRN	J7-P1	20v DC	23-800 090-8001-00T
#13	MR. HANKEY (DOWN)	Q13	I/O Pwr. Drvr.	BLU-GRN	J9-P6	YEL-VIO	J10-P4/5	50v DC	23-1100 090-8030-00T
#14	KENNY PIVOT (DEAD)	Q14	I/O Pwr. Drvr.	BLU-BLK	J9-P7	YEL-VIO	J10-P4/5	50v DC	22-1080 090-8032-00T
#15	LEFT FLIPPER (50v RED/YEL)	Q15	I/O Pwr. Drvr.	ORG-GRY	J9-P8	RED-YEL GRY-YEL	J10-P1/2	50v DC	23-1100 090-8030-00T
#16	RIGHT FLIPPER (50v RED/YEL)	Q16	I/O Pwr. Drvr.	ORG-VIO	J9-P9	RED-YEL BLU-YEL	J10-P1/2	50v DC	23-1100 090-8030-00T
Low Current Coils Group 1		Drive Transistor (D.T.)	Driver Output Board	D.T. Control Line Color	D.T. Control Line Connect	Power Line Color	Power Line Connection	Power Voltage	Coil GA/Turn Bulb or Meter
#17	RIGHT SLINGSHOT	Q17	I/O Pwr. Drvr.	VIO-BRN	J7-P2	BRN	J7-P1	20v DC	23-800 090-8001-00T
#18	FLASH TOP VUK *1	Q18	I/O Pwr. Drvr.	VIO-RED	J7-P3	ORG	J6-P10	20v DC	#89 Bulb 165-5000-89
#19	KENNY LT	Q19	I/O Pwr. Drvr.	VIO-ORG	J7-P4	BRN	J7-P1	20v DC	24-940 090-8038-00T
#20	KENNY RT	Q20	I/O Pwr. Drvr.	VIO-YEL	J7-P6	BRN	J7-P1	20v DC	24-940 090-8038-00T
#21	LT OUTLANE (UK ONLY)	Q21	I/O Pwr. Drvr.	VIO-GRN	J7-P7	BRN	J7-P1	20v DC	28-1050 090-8030-00T
#22	RT OUTLANE (UK ONLY)	Q22	I/O Pwr. Drvr.	VIO-BLU	J7-P8	BRN	J7-P1	20v DC	28-1080 090-8030-00T
#23	UP/DOWN POST (UK ONLY)	Q23	I/O Pwr. Drvr.	VIO-BLK	J7-P9	BRN	J7-P1	20v DC	23-1100 090-8030-00T
#24	OPTIONAL COIN METER	Q24	I/O Pwr. Drvr.	VIO-GRY	J7-P10	RED	J16-P7	5v DC	Meter 5v 090-8000-00
D code On Terminal Strip (if coded)									
Flash Lamps (FLASH)		Drive Transistor (D.T.)	Driver Output Board	D.T. Control Line Color	D.T. Control Line Connect	Power Line Color	Power Line Connection	Power Voltage	Bulb Type
#F1	FLASH STAN *2	Q25	I/O Pwr. Drvr.	BLK-BRN	J6-P1	ORG	J6-P10	20v DC	#89 Bulb 165-5000-89
#F2	FLASH CHEF *2	Q26	I/O Pwr. Drvr.	BLK-RED	J6-P2	ORG	J6-P10	20v DC	#89 Bulb 165-5000-89
#F3	FLASH KENNY *2	Q27	I/O Pwr. Drvr.	BLK-ORG	J6-P3	ORG	J6-P10	20v DC	#89 Bulb 165-5000-89
#F4	FLASH KYLE *2	Q28	I/O Pwr. Drvr.	BLK-YEL	J6-P4	ORG	J6-P10	20v DC	#89 Bulb 165-5000-89
#F5	FLASH CARTMAN *2	Q29	I/O Pwr. Drvr.	BLK-GRN	J6-P5	ORG	J6-P10	20v DC	#89 Bulb 165-5000-89
#F6	FLASH KENNY *1 BACK *2	Q30	I/O Pwr. Drvr.	BLK-BLU	J6-P6	ORG	J6-P10	20v DC	#906 Bulb 165-8004-00 #89 Bulb 165-5000-89
#F7	FLASH MR HANKEY/TOILET *3	Q31	I/O Pwr. Drvr.	BLK-VIO	J6-P7	ORG	J6-P10	20v DC	#89 Bulb 165-5000-89
#F8	FLASH SUPER VUK *1	Q32	I/O Pwr. Drvr.	BLK-GRY	J6-P8	ORG	J6-P10	20v DC	#89 Bulb 165-5000-89
Note: In Test Flash Lamps Menu (Flash Icon), Flashers tested are Flash Lamps. F1-F8 ONLY. Test all others in Single or Cycling Coil Tests.									



Backbox I/O Power Driver Board Detailed Wiring Diagram

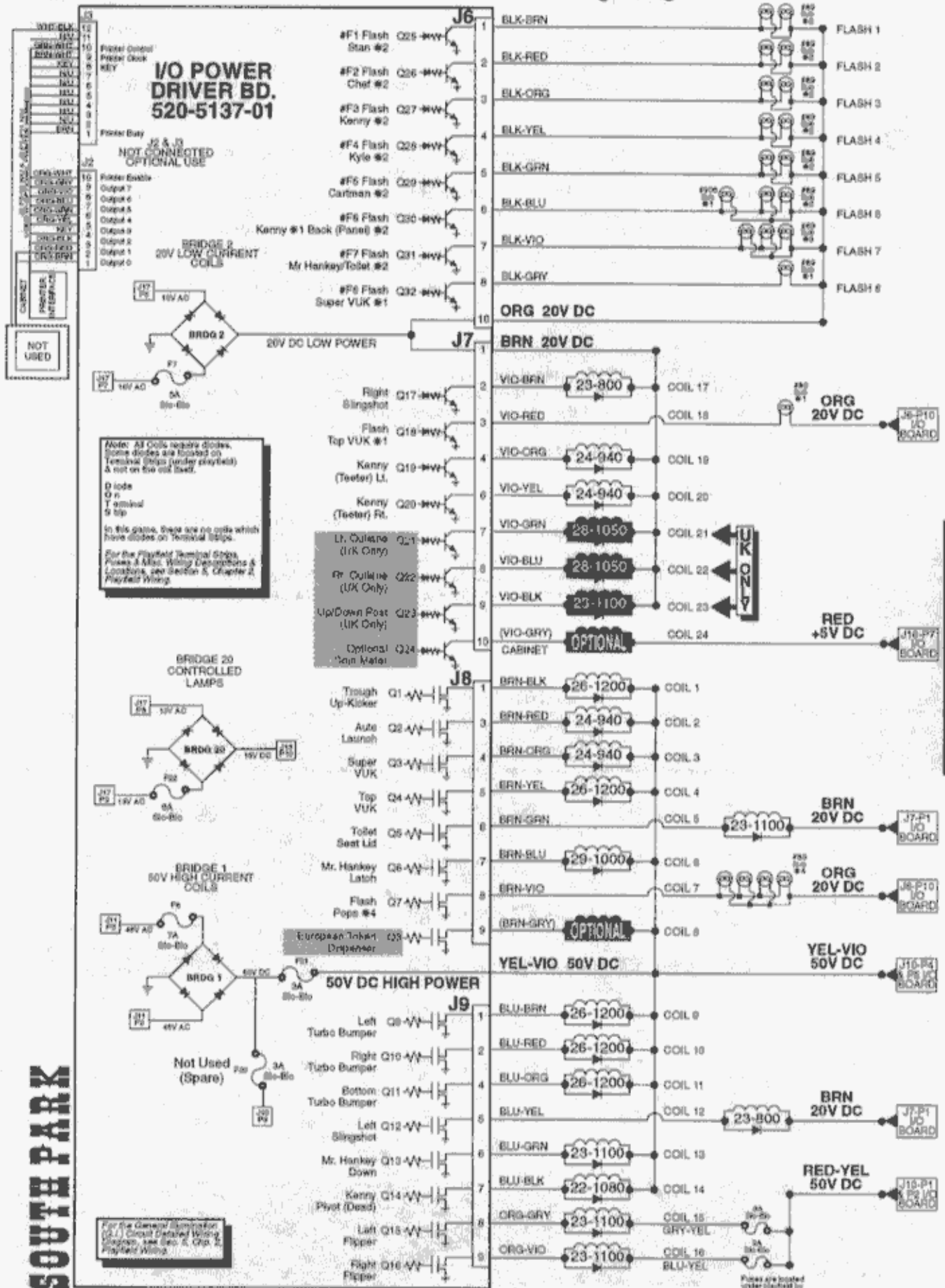

Section 3 | Diags.





Go To Lamp Menu

From the **DIAGNOSTICS MENU**, select the "LAMP" *Icon* with either **Red "LEFT"** or **Green "RIGHT" Button** and press the **Black "ENTER" Button**. Controlled lamps are configured in an 8 x 10 Matrix of Columns (Lamp Drives) and Rows (Lamp Returns) with up to 80 lamps possible. The Lamp Test Menu consists of four (4) parts: Single Lamp Test, Test All Lamps, Row Lamp Test and Column Lamp Test.



Single Lamp Test

To initiate, from the **LAMP MENU**, select the "ONE" *Icon* with either **Red or Green Button** and press the **Black Button**. Select either the "-" or "+" *Icons*. Start with the "+" *Icon* to start the manual Lamp Test from Column 1, Row 1, Switch 1. Press the **Black Button** on the "+" *Icon*, as each lamp is selected, the lamp will light at its location on the playfield as well as the display, indicating the Lamp Matrix Grid Position, lamp name with the corresponding number, Return (Row) Wire & Color, Drive (Column) Wire & Color, and associated drive transistors. Press the **Black Button** again to move forward in the test. To test and view a particular lamp, select the "RUN" *Icon* and press the **Black Button**. Each time the **Black Button** is pushed, the lamp will light-up on the playfield, with the display indicating the lamp information. Continue with the same procedure to run through the entire test.



Test All Lamps

To initiate, from the **LAMP MENU**, select the "ALL" *Icon* with either **Red or Green Button** and press the **Black Button**. If still in Single Lamp Test (or any 1 of the 4 tests), select the "PREV" *Icon* to return to Lamp Menu or selecting either of the "ARROW" *Icons* will move through the tests, keep activating until Test All Lamps is displayed. The display will indicate "ALL LAMPS ON" and the lamps on the playfield will be lit, alternating between the rows in the Lamp Matrix Grid.



Row & Column Lamp Tests

To initiate, from the **LAMP MENU**, select the "ROW" or "COL" *Icon* with either **Red "LEFT"** or **Green "RIGHT" Button** and press the **Black Button**. If still in a previous test, select the "PREV" *Icon* to return to Lamp Menu or selecting either of the "ARROW" *Icons* will move through the tests, keep activating until Row or Column Lamp Test (whichever desired) is displayed. In this test, each set of lamps in each Row or Column of the Lamp Matrix Grid (relative to each test) will light-up on the playfield and is indicated in the display.



LAMP MATRIX GRID

Column (18v)	1: U17	2: U16	3: U15	4: U14	5: U13	6: U12	7: U11	8: U10
Row (GND)	YEL-BRN J13-P9	YEL-RED J13-P8	YEL-ORG J13-P7	YEL-BLK J13-P6	YEL-GRN J13-P5	YEL-BLU J13-P4	YEL-VIO J13-P3	YEL-GRY J13-P1
1: Q33	CHEF FACE #555 Bulb 1	CHEF #2 #555 Bulb 2	CHEF #3 #555 Bulb 3	CHEF #4 #555 Bulb 4	CHEF ARROW #555 Bulb 5	MYSTERY #555 Bulb 6	SPOOKY VISION #555 Bulb 7	EXTRA BALL #555 Bulb 8
2: Q34	STAN FACE #555 Bulb 9	STAN #2 #555 Bulb 10	STAN #3 #555 Bulb 11	STAN #4 #555 Bulb 12	STAN ARROW #555 Bulb 13	SKILL SHOT #555 Bulb 14	VOLCANO #555 Bulb 16	ANAL PROBE #555 Bulb 15
3: Q35	KENNY FACE #555 Bulb 17	KENNY #2 #555 Bulb 18	KENNY #3 #555 Bulb 19	KENNY #4 #555 Bulb 20	KENNY ARROW #555 Bulb 21	SUPER JACKPOT #555 Bulb 22	MULTIBALL READY 555# ulb 23	SOUTH PARK SIGN #555 Bulb 24
4: Q36	KYLE FACE #555 Bulb 25	KYLE #2 #555 Bulb 26	KYLE #3 #555 Bulb 27	KYLE #4 #555 Bulb 28	KYLE ARROW #555 Bulb 29	KENNY ASSEMBLY #555 Bulb 30	NOT USED 31	NOT USED 32
5: Q37	CARTMAN FACE #555 Bulb 33	CARTMAN #2 #555 Bulb 34	CARTMAN #3 #555 Bulb 35	CARTMAN #4 #555 Bulb 36	CARTMAN ARROW #555 Bulb 37	LEFT TUR-BO BUMPER 555# Bulb 38	RIGHT TUR-BO BUMPER 555# Bulb 39	BTM TUR-BO BUMPER 555# Bulb 40
6: Q38	LEFT 5-BANK BOTTOM #555 Bulb 41	LEFT 5-BANK #2 #555 Bulb 42	LEFT 5-BANK #3 #555 Bulb 43	LEFT 5-BANK #4 #555 Bulb 44	LEFT 5-BANK TOP #555 Bulb 45	TOILET S-U LT #555 Bulb 46	NOT USED 47	TOILET S-U RT #555 Bulb 48
7: Q39	NOT USED 49	RT. 3-BANK BOTTOM #555 Bulb 50	RT. 3-BANK MIDDLE #555 Bulb 51	RT. 3-BANK TOP #555 Bulb 52	LEFT OUTLANE #555 Bulb 53	LEFT RE-TURN LANE #555 Bulb 54	RIGHT RE-TURN LANE #555 Bulb 55	RIGHT OUTLANE #555 Bulb 56
8: Q40	MR. HANKEY: BOTTOM #555 Bulb 57	MR. HANKEY: BODY #555 Bulb 58	MR. HANKEY: LT HAND #555 Bulb 59	MR. HANKEY: RT HAND #555 Bulb 60	MR. HANKEY: HEAD #555 Bulb 61	MR. HANKEY: HAT #555 Bulb 62	POP BUMPER TARGET LT #555 Bulb 63	POP BUMPER TARGET RT #555 Bulb 64
9: Q41 NOT USED RED-WHT J12-P10	NOT USED 65	NOT USED 66	NOT USED 67	NOT USED 68	NOT USED 69	NOT USED 70	NOT USED 71	NOT USED 72
10: Q42 NOT USED RED J12-P11	NOT USED 73	NOT USED 74	NOT USED 75	NOT USED 76	NOT USED 77	NOT USED 78	NOT USED 79	NOT USED 80



Lamp Matrix Grid Locations

The lamp locations correspond with the Lamp N^o in the Lamp Matrix Grid on the previous page.

Legend Note:

- = Lamps mounted above playfield.
- = Lamps mounted below playfield.

The following Lamps are not used:

- 31 - 32 47 49 65 - 80

The following Bulbs are used in the Lamp Matrix Grid (See Table Grid on previous page for details):



#555 Bulb (Wedge)
165-5062-00



#44 Bulb (Bayonet)
165-5000-44

Typical Lamp Schematic

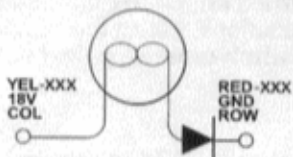

Typical Lamp Wiring

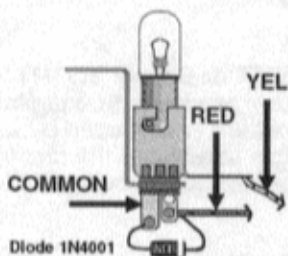

Note:
All Lamps require diodes.
Some diodes are located on Terminal Strips (under playfield) & not on the lamp itself.

D iode
O n
T erminal
S trip

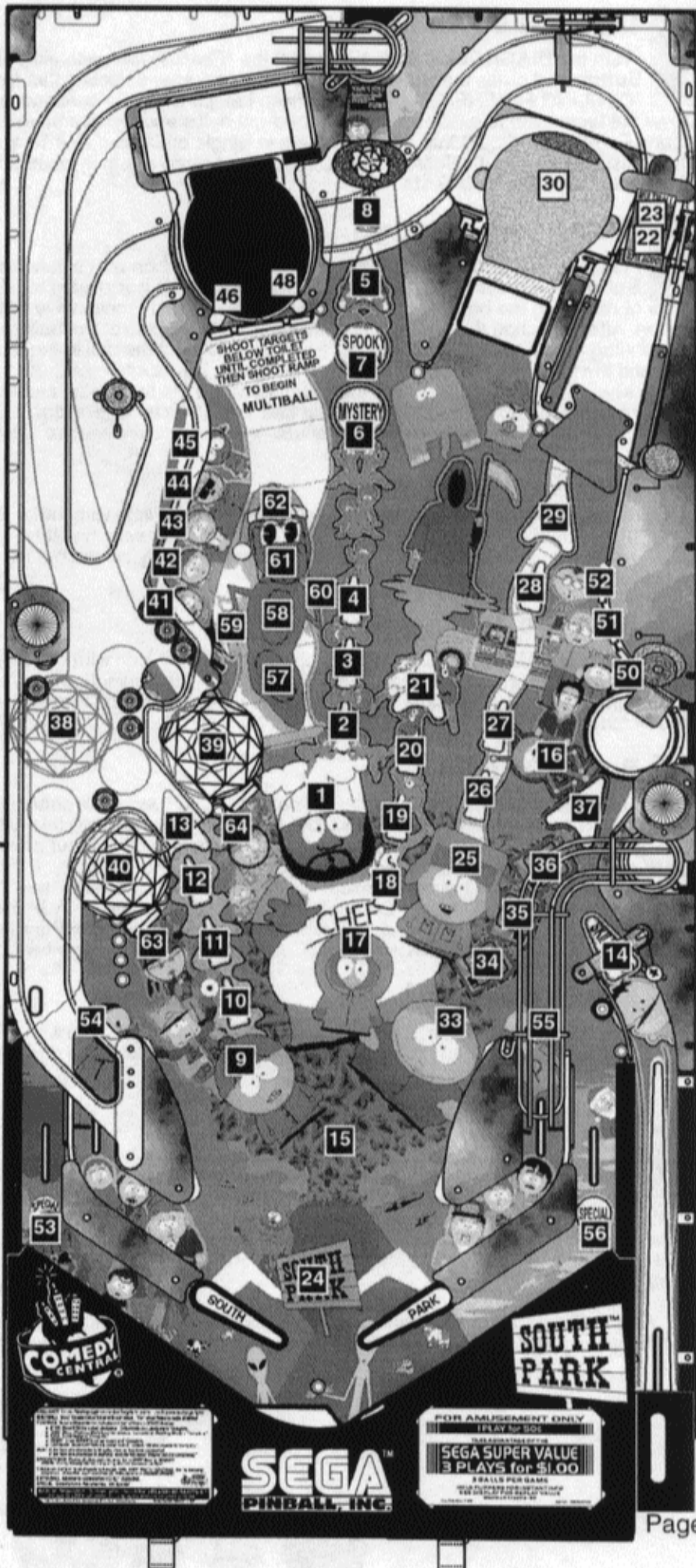



Test Flash Lamps

From the **DIAGNOSTICS MENU**, select the "FLASH" *Icon* with either **Red "LEFT"** or **Green "RIGHT"** **Button** and press the **Black "ENTER" Button**. After selecting this *Icon* the display will indicate "CYCLING FLASHERS" and all the Flash Lamps will cycle continuously until the test is exited. This test allows the technician to easily spot any burned-out bulbs and replace them. Flashers tested are Flash Lamps in Positions F1-F8 (Q25-Q32) Only. Test all others in Single or Cycling Coil Tests. **Important:** The **Power Interlock Switch** must be pulled out. **Note:** In this game Flash Lamps are also located in Coil Positions #6 & #7. **TO TEST USE Single or Cycling Coil Tests.**



Clear Ball Trough

From the **DIAGNOSTICS MENU**, select the "CLR" *Icon* with either **Red "LEFT"** or **Green "RIGHT"** **Button** and press the **Black "ENTER" Button**. This is provided to allow the technician a simple method of removing the balls from the trough and also, to test functionality of the trough, ensuring proper trough operation. After selecting this *Icon* the display will show a graphic of the ball trough with balls in the trough with it's corresponding switch number. Select the "RUN" *Icon* to eject the ball in the first position. Simultaneously, the display and the playfield will eject the ball to the Trough Up-Kicker, eject from the Trough Up-Kicker into the Shooter Lane and will be ejected onto the playfield where the technician can easily retrieve the pinball or allow the ball(s) to re-enter the trough to continue Clear Ball Trough Test. **Important:** The **Power Interlock Switch** must be pulled out. **⚠ Caution:** Continuous use of above test may overheat the Trough Up-Kicker Coil. **⚠**



Technician Alert

From the **DIAGNOSTICS MENU**, select the "TECH" *Icon* with either **Red "LEFT"** or **Green "RIGHT"** **Button** and press the **Black "ENTER" Button**. After selecting this *Icon* the display will indicate if there are any faulty switches (i.e., switches that are normally closed but remain open or open switches that have not been closed (activated) in 50 games.)



Service Phone

From the **DIAGNOSTICS MENU**, select the "SERV" *Icon* with either **Red "LEFT"** or **Green "RIGHT"** **Button** and press the **Black "ENTER" Button**. After selecting this *Icon* the display will indicate a phone number to call if technical assistance is required (the phone number is different for each *Country Dip Switch Setting*).



Begin Play Test

From the **DIAGNOSTICS MENU**, select the "PLAY" *Icon* with either **Red "LEFT"** or **Green "RIGHT"** **Button** and press the **Black "ENTER" Button**. After selecting this *Icon* the technician can test certain play functions to insure all switch activated coils function without entering game play. For example, by rolling the ball over the Shooter Lane switch, the Autoplunger should fire. If it kicks too early or too late, the switch actuator should be adjusted to compensate for this error. If it fails to fire, use the Switch Test or Coil Test to help determine the cause of the failure. During this function, similar tests may be performed on the "Ejects", Slingshots, Vertical Up-Kickers, Pop Bumpers, etc. in the game. For unique Play Test functions, select the "GAME SPECIFIC" *Icon* in the **DIAGNOSTICS MENU**. **Important:** The **Power Interlock Switch** must be pulled out.



Fire Knocker

From the **DIAGNOSTICS MENU**, select the "KNOCKER" *Icon* with either **Red "LEFT"** or **Green "RIGHT"** **Button** and press the **Black "ENTER" Button**. The digitally mastered "Knocker" is sounded.



Sound / Speaker Test

From the **DIAGNOSTICS MENU**, select the "SPKR" *Icon* with either **Red "LEFT"** or **Green "RIGHT"** **Button** and press the **Black "ENTER" Button**. The BSMT 2000 Sound System produces true digital stereo sound from Backbox & Cabinet Speakers or "Mono" on the Cabinet Speaker (when used by itself). After selecting this *Icon*, select the "-" or "+" *Icons* and press the **Black "ENTER" Button** to activate the first test. Repeat to visually see & hear all tests. Select the "RUN" *Icon* to activate the test chosen without moving to the next test.

Note: During Sound Tests, the display shows the speaker identification and the corresponding sound(s). The sound functions allow verification that both channels are functioning properly & that the speaker connections are correct.

Sound / Speaker Test Continued Next Page





Speaker Phase Testing

Connections to each of speakers are polarized and each must be connected appropriately for the best quality sound. If one speaker has the positive and negative connections reversed with respect to the other one, bass frequencies will not be produced properly and the overall sound quality will be poor. To test for proper speaker phasing, use the sound test to cycle through the Backbox & Cabinet, and Backbox Sine (repeated) functions. If the Cabinet Sine produces more volume and bass than the Left Sine, the speakers are connected properly. If it produces the same or less, one speaker is connected improperly. To isolate and correct reversed speaker connections, one of two methods may be used.

1. Check each speaker for polarity markings. If the speakers have polarity markings, verify that the Backbox Speaker RED/WHT Wire and the Cabinet Speaker YEL/WHT Wire is connected to the negative (-) terminal.
2. Disconnect the speaker output connector from the CPU / Sound Board and connect a 1.5-volt battery across each speaker pair one at a time while observing the speakers. Make sure the positive battery terminal is connected to the positive lead (CN4, Pin-3 (RED/BLK) or Pin-6 (YEL/BLK)) each time. As the connection is made, check speaker cone movement; proper connections are indicated by outward movement.

Auto / Manual Tests	Sounds Produced
Speaker Test	Tone
Sound/OPSYS EPROM (Loc. U7)	Level 1-3 (Music Test)
Voice ROM 1 (Loc. U17)	Speech Pattern 1
Voice ROM 2 (Loc. U21)	Speech Pattern 2
Voice ROM 3 (Loc. U36)	Speech Pattern 3
Voice ROM 4 (Loc. U37)	Speech Pattern 4

Note: Voice ROMs 1 - 4 = 8MB. The CPU/Sound Board must have a Jumper at W6 to accept 8MB ROMs.



Begin Burn In

From the **DIAGNOSTICS MENU**, select the "BURN" *Icon* with either Red "LEFT" or Green "RIGHT" Button and press the Black "ENTER" Button. After selecting this *Icon* the Begin Burn-In Test will start. At this stage the game will exercise all CPU I/O Functions (Dot Matrix Display Test, Coil Testing, Lamp Testing, Sound, etc.). This is provided to constantly exercise sounds, coils, etc... Cumulative Burn-In minutes will be displayed. To reset Burn-In minutes to 00, select the "RESET" *Icon* in the **MAIN MENU** and select the "FACT" *Icon* (Factory Reset). See Chapter 5, Go To Reset Menu, of this section.



Dot Matrix Test

From the **DIAGNOSTICS MENU**, select the "DOT TEST" *Icon* with either Red "LEFT" or Green "RIGHT" Button and press the Black "ENTER" Button. After selecting this *Icon* the Dot Matrix Test immediately begins. The display will immediately illuminate & cycle for 1 pass of each test continuously for each of the following tests:

1. Illuminates 1 vertical column of dots, turning it off & illuminating the next column, until each column has been individually lit, while the other columns are off.
2. Illuminates 1 horizontal row of dots, turning it off & illuminating the next row, until each row has been individually lit, while the other rows are off.
3. Illuminates all the dots, except for one column from left to right.
4. Illuminates all the dots, except for one row from top to bottom.
5. Illuminates every other dot lit, in both the rows and columns.
6. Illuminates all dots at 30%, 70% & 100% brightness.

Note: Pressing any button will exit the test & return to **DIAGNOSTICS MENU**.

Dot Matrix Display Explained

The display utilizes a Micro-Processor Control Board mounted in piggyback fashion to the Dot Matrix Display (128 X 32) Driver Board. The purpose behind this board is to provide more information to the operator as well as displaying graphics to the player.

The board is controlled by a 6809E Microprocessor and its personality ROM (Unique to the Game). It receives Data, Reset & Clock Information from the CPU/Sound Board via the ribbon cable and sends back multiple Status and Busy Signals to the CPU. This is to insure synchronized communication between the CPU and the Display Controller Board. The Drivers for the rows and columns are provided on 5 surface mounted integrated circuits on the Dot Matrix Display Driver Board.





South Park Specific (Mr. Hankey Test)

To initiate, from the **DIAGNOSTICS MENU**, select the "PARK" *Icon* with either the **Red "LEFT"** or **Green "RIGHT" Button** and press the **Black "ENTER" Button**. This will bring up the **SOUTH PARK SPECIFIC MENU**. Similar to "BEGIN PLAY TEST," this menu is used to test and adjust Game Specific Features. The feature in this game is **MR. HANKEY TEST**.

MR. HANKEY TEST

PULSE LENGTH: 30



This test allows you to operate the **MR. HANKEY LATCH (Coil Q6) [UP]** and the **MR. HANKEY (DOWN) (Coil Q13) [DOWN]** outside of Game Mode for the purpose of troubleshooting and adjustment.

Test Procedure:

Select the "UP" *Icon* with either the **Red "LEFT"** or **Green "RIGHT" Button** and press the **Black "ENTER" Button**. This will energize the **MR. HANKEY LATCH Coil (Q6)** releasing the spring loaded Mr. Hankey Device. Select the "DOWN" *Icon* with either the **Red "LEFT"** or **Green "RIGHT" Button** and press the **Black "ENTER" Button**. The **MR. HANKEY (DOWN) Coil (Q13)** will energize, pulling Mr. Hankey back into the Toilet Tank and re-latching the assembly (...the Metal Yoke on the Plunger catches under the Trip Coil Arm Assembly.).

Adjustment Procedure:

Using the or *Icons* you can vary the strength of the [DOWN] Coil (Q13) (the Display will indicate this.). The **Adjustment Range** is **10 (SOFT)** to **60 (HARD)**. The **Factory Setting** is **30**. Your goal is to have the [DOWN] Coil pull the Mr. Hankey Assembly into the Toilet Tank in one **PULSE** (with no "chattering"). Starting at the lowest value of "10", increment the value by two (2) (e.g. 10-12, 12-14, etc.) until you get a smooth "One-Shot-Pull" without any chattering. Select the "DOWN" *Icon* to test the "pull"; select the "UP" *Icon* to release the Mr. Hankey Assembly so you may try another Pulse Length, if desired. Test the action of this assembly a minimum of five (5) times ensuring each time was a smooth "One-Shot-Pull."

BEFORE EXITING THIS MENU, ENSURE YOU SELECT THE "DOWN" ICON TO PULL THE ASSEMBLY BACK INTO THE TANK.

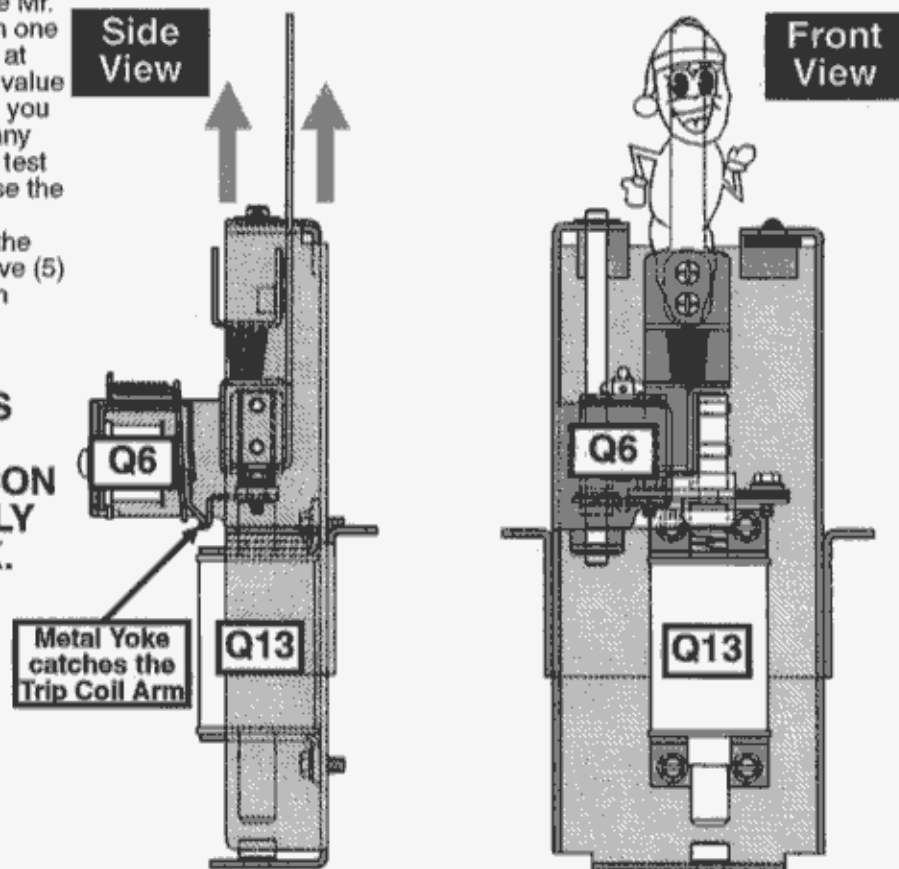



Dr. Pinball (Flow Chart Menus)

To initiate, from the **DIAGNOSTICS MENU**, select the Cross "DR." *Icon* with either the **Red "LEFT"** or **Green "RIGHT" Button** and press the **Black "ENTER" Button**. This will bring you (the operator / technician) into **DR. PINBALL** (Flow Chart Menus) which offers you a choice of three sub-menus: Coil "DR.," Switch "DR." and Lamp "DR." *Icons*. Selecting a particular sub-menu will give you a choice of which specific Coil (any and all coil assemblies such as Flippers, VUKs, Magnets, etc.), Switch or Lamp circuit needs to be diagnosed. The display will now ask a question or give a procedure to follow such as "Does the lamp turn on?" or "Check bridge rectifier BR-20, if short replace." When Dr. Pinball asks a question or request a procedure the Dr. will expect a response such as "no" or "yes" (see below examples of the *Mini-Icons* which will prompt the operator). You the operator/technician must respond by using your **Flipper Buttons** to "SELECT" a *Mini-Icon* and the **Start Button** to "ENTER" your selection.

The following are the *Mini-Icons* with explanations for the Dr. Pinball Sub-Menus to follow:



→ Select a Coil, Lamp or Switch to diagnose with "-" or "+" *Icon*; Then select the "RUN" *Icon* to activate the choice. "PREV" goes back to previous question. "QUIT" exits Portals completely. Help "?" gives direction on button usage.



→ Seen when question is being asked on the Display. Select "YES" or "NO" to answer question given. "END" lets you select a new item to test. "PREV", "QUIT" and "?" (see first example above).



→ Seen when diagnosis is given. Select any *Icon* for your next step. "END" lets you select a new item to test. "PREV", "QUIT" and "?" (see first example above).



→ In Coil Flow Chart Menu, select "PULSE" to pulse the coil selected. "END" lets you select a new item to test. "PREV", "QUIT" and "?" (see first example above).



Coil Flow Chart

To initiate, from the **DR. PINBALL MENU**, select the Coil "DR." *Icon* with either the **Red or Green Button** and press the **Black Button**. This is the Coil Flow Chart. Follow the questions, answering by using the *Mini-Icons* in the display.



Switch Flow Chart

To initiate, from the **DR. PINBALL MENU**, select the Switch "DR." *Icon* with either the **Red or Green Button** and press the **Black Button**. This is the Switch Flow Chart. Follow the questions, answering by using the *Mini-Icons* in the display.



Lamp Flow Chart

To initiate, from the **DR. PINBALL MENU**, select the Lamp "DR." *Icon* with either the **Red or Green Button** and press the **Black Button**. This is the Lamp Flow Chart. Follow the questions, answering by using the *Mini-Icons* in the display.



SOUTH PARK GAME AUDIT TABLE



Copy for Field Audit Tracking Performance (Use blank columns to fill-in Audit Info.).



Earnings Audits 1-12

Audit Name	Fill-In	Audit Name	Fill-In	Audit Name	Fill-In
1 TOTAL PAID CREDITS		5 COINS THRU LEFT SLOT		9 TOTAL COINS	
2 FREE GAME PERCENTAGE		6 COINS THRU RIGHT SLOT		10 TOTAL EARNINGS	
3 AVERAGE BALL TIME		7 COINS THRU CENTER SLOT		11 METER CLICKS	
4 AVERAGE GAME TIME		8 COINS THRU 4TH SLOT		12 SOFTWARE METER	



Sega Audits 13-55

Audit Name	Fill-In	Audit Name	Fill-In	Audit Name	Fill-In
13 TOTAL BALLS PLAYED		28 20M—49.9M SCORES		43	
14 TOTAL EXTRA BALLS		29 50M—69.9M SCORES		44	
15 EXTRA BALL PERCENT		30 70M—99.9M SCORES		45	
16 REPLAY 1 AWARDS		31 100M—129.9M SCORES		46	
17 REPLAY 2+ AWARDS		32 130M+ SCORES		47	
18 TOTAL REPLAYS		33 AVERAGE SCORES		48	
19 REPLAY PERCENT		34 SERVICE CREDITS		49	
20 TOTAL SPECIALS		35 BALL SEARCH STARTED		50	
21 SPECIAL PERCENT		36 LOST BALL FEEDS		51	
22 TOTAL MATCHES		37 LOST BALL GAME STARTS		52 LEFT FLIPPER USED	
23 HIGH SCORE AWARDS		38 LEFT DRAINS		53 RIGHT FLIPPER USED	
24 HIGH SCORE PERCENT		39 CENTER DRAINS		54	
25 TOTAL FREE PLAYS		40 RIGHT DRAINS		55	
26 TOTAL PLAYS		41 SLAM TILTS			
27 0—19.9M SCORES		42 TOTAL BALLS SAVED			

Section 3 | Audits



South Park Audits 56-99 (All Audits Subject to Change)

Audit Name	Fill-In	Audit Name	Fill-In	Audit Name	Fill-In
56 LEFT ORBIT		72 MBALL RESTARTED		88 VOLCANO STARTED	
57 TOP VUK VIA ORBIT		73 MBALL JACKPOTS		89 VOLCANO COMPLETED	
58 RAMP		74 SUPER JACKPOTS LIT		90 SUPER FART BUMPERS LIT	
59 RIGHT 3-BANK COMP		75 SUPER JACKPOTS		91 POP BUMPER HITS	
60 LEFT 5-BANK COMP		76 CARTMAN MODE STARTED		92 MYSTERY LIT	
61 CENTER 3-BANK HITS		77 CARTMAN MODE COMPLETED		93 MYSTERY SCORED	
62 KENNY OPTO		78 KYLE MODE STARTED		94 SKILL SHOT MADE	
63 KENNY UNDERTROUGH		79 KYLE MODE COMPLETED		95	
64 TOILET UNDERTROUGH		80 KENNY MODE STARTED		96	
65 CARTMAN UNDERTROUGH		81 KENNY MODE COMPLETED		97	
66 SUPER VUK		82 CHEF MODE STARTED		98	
67 TOP VUK		83 CHEF MODE COMPLETED		99	
68 MBALL READY		84 STAN MODE STARTED			
69 MULTIBALL START		85 STAN MODE COMPLETED			
70 2+ MBALL START		86 SPOOKY VISION LIT			
71 MULTIBALL RESTART LIT		87 SPOOKY VISION STARTED			

Location:

CPU Version:
 Display Version:
 Date Audited:
 Audited By:

