

Bally[®]

August 1993
16-20020-103

JUDGE DREDD[™]

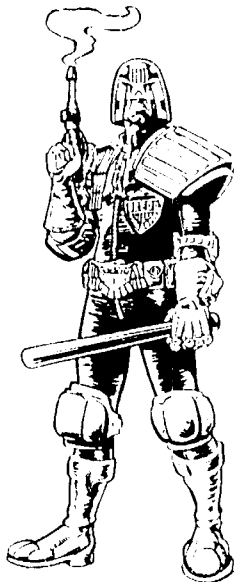

Operators Handbook

Midway Manufacturing Company
3401 North California Avenue
Chicago, Illinois 60618

TABLE OF CONTENTS

RUBBER RINGS.....	1
RAMPS.....	2
LOWER PLAYFIELD PARTS.....	3
UPPER PLAYFIELD PARTS.....	4
UPPER PLAYFIELD PARTS LOCATIONS.....	5
SOLENOID TABLE.....	6
SOLENOID LOCATIONS.....	7
LAMP MATRIX.....	8
LAMP LOCATIONS.....	9
SWITCH MATRIX.....	10
SWITCH LOCATIONS.....	10, 11
MAIN MENU.....	12
FUSE LIST.....	13

RUBBER PARTS

ITEM	PART NUMBER	DESCRIPTION	QTY.
A	23-6556	Black Bumper Sleeve	8
B	23-6641	Rubber Bumper	2
C	23-6696	1" Black Flipper Rubber	1
D	23-6686	Round Rubber Pad	3
E	23-6694-5	3/4" Black Ring	4
F	23-6694-6	1" Black Ring	1
G	23-6694-10	2 1/2" Black Ring	2
H	23-6695	1 1/2" Black Flipper Rubber	3

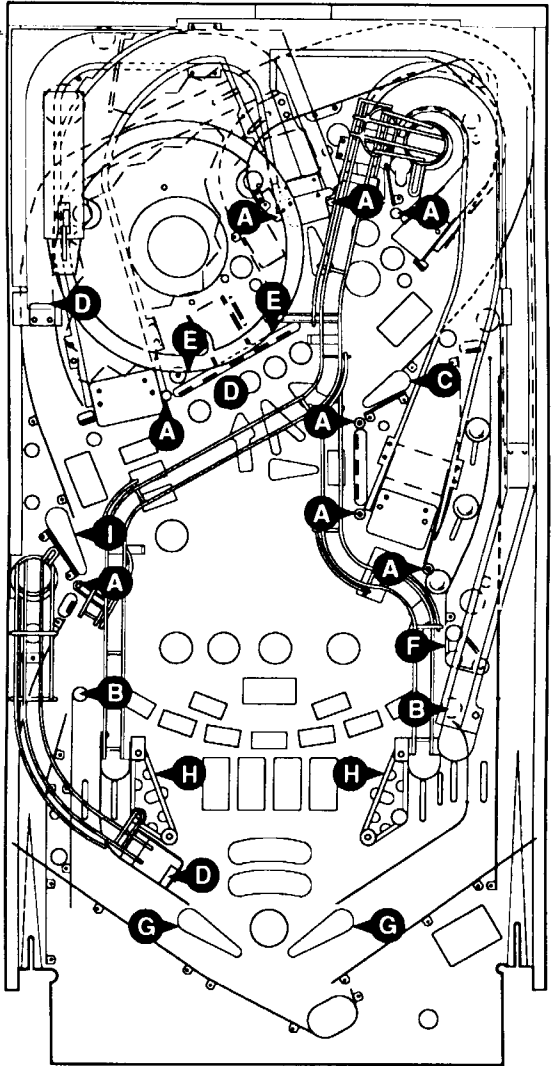

RAMPS

<u>Item</u>	<u>Part Number</u>	<u>Description</u>
-------------	--------------------	--------------------

- | | | |
|----|----------|-----------------------|
| 1. | A-17170 | Ramp Assembly |
| a) | 01-11424 | Bracket |
| b) | A-16908 | Opto LED Assembly-RTV |
| c) | A-16909 | Opto Photo Trans.-RTV |
| d) | 01-11784 | Opto Switch Bracket |
| 2. | A-17231 | Ramp Assembly |
| a) | A-16908 | Opto LED Assembly-RTV |
| b) | A-16909 | Opto Photo Trans.-RTV |
| c) | 01-12026 | Opto Mounting Plate |
| 3. | A-16932 | Wire Ramp Assembly |
| 4. | A-16579 | Ramp Assembly |
| 5. | A-16630 | Ramp Assembly |
| 6. | A-17132 | Wire Ramp Assembly |
| 7. | A-16987 | Wire Ramp Assembly |

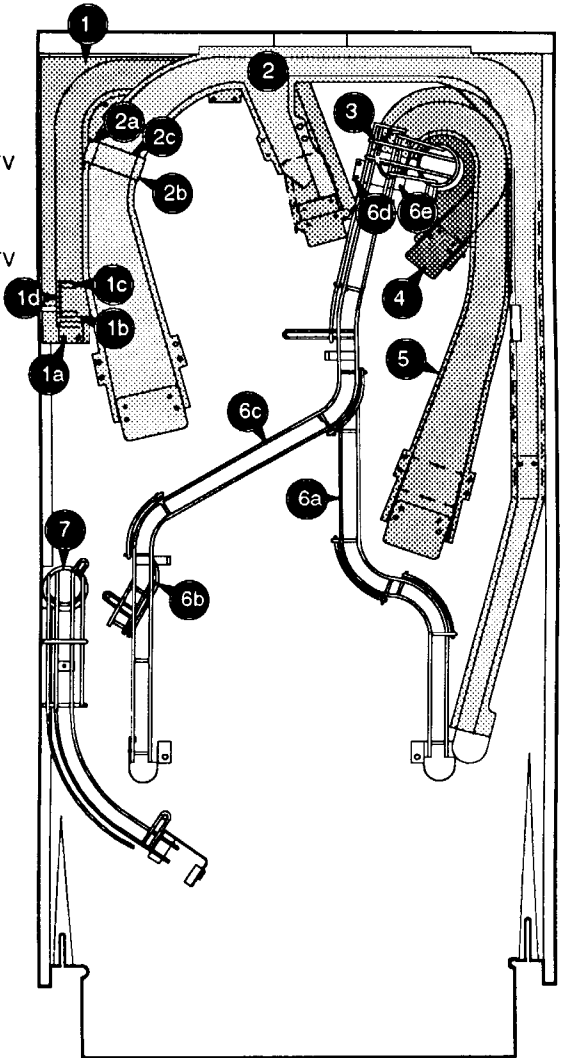

LOWER PLAYFIELD PARTS

Item	Part Number	Description
1.	A-14525	Kicker Bracket Assembly
2.	01-11781	Leg Support (2 Used)
3.	A-16765	Outhole Ball Trough Assembly
4.	A-15205-R-2	Flipper Assembly, Lwr. Right
5.	B-12665	Kicker Arm (Slingshot) Assy., Right
	A-14369-R	Coil & Bracket Assembly
	10-128	Spring
	B-8284-1	Kicker Switch Assembly
6.	B-12224	Single Lamp Board
7.	A-16843	4-Lamp Board
8.	A-15205-R	Flipper Assembly, Upper Right
9.	A-16936	Kicker Bracket Assembly
10.	A-16841	5-Lamp Board
11.	A-15769	Ball Popper & Opto Assembly
12.	A-16637-2	Pfhd. Slide Mechanism, Right
13.	01-10726	Rear Guide Leg (2 Used)
14.	A-16802	Diverter Assembly
15.	A-16947	Trough Assembly
16.	A-15542	Motor EMI (2 Used)
17.	A-16637-1	Pfhd. Slide Mechanism, Left
18.	A-17247	Lifter Assembly
19.	A-16968	Trough Assembly
20.	A-16478	Planet Assembly
21.	A-16976-L	Flipper Assembly, Upper Left
22.	A-16580	Ball Popper Assembly
23.	A-16833	Trough Assembly
24.	A-15576	7-Opto Switch Board (2 Used)
25.	A-16844	4-Lamp Board
26.	A-16839	14-Lamp Combo PCB
27.	B-12665	Kicker Arm (Slingshot) Assy., Left
	A-14369-L	Coil & Bracket Assembly
	10-128	Spring
	B-8284-1	Kicker Switch Assembly
28.	A-16929	4-Lamp Board
29.	A-15205-L-2	Flipper Assembly, Lwr. Left
30.	01-8419	Pfhd. Hanger Bracket (2 Used)

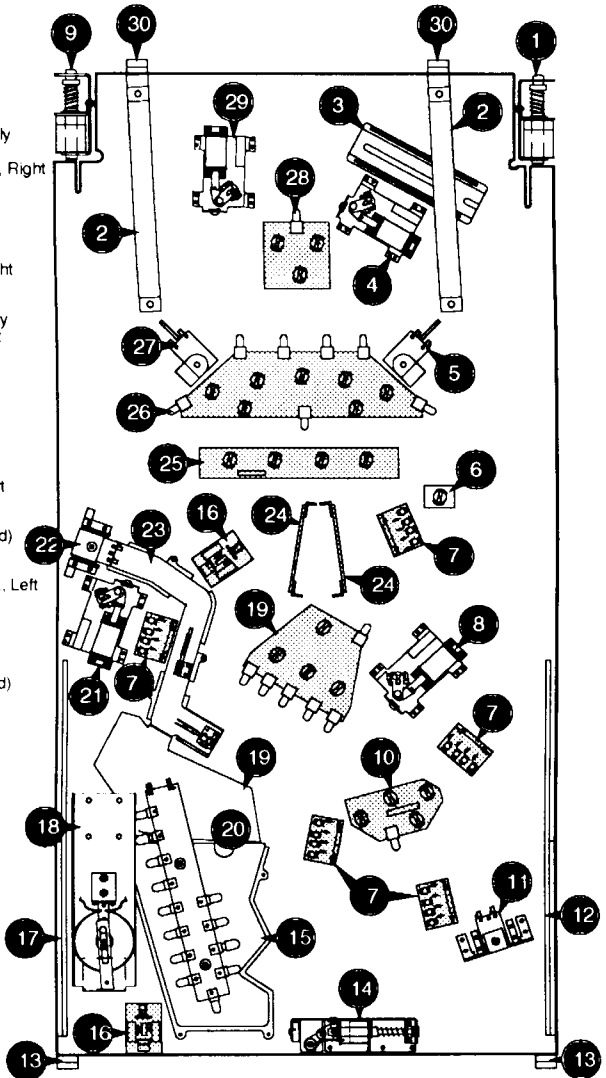

Underside of Playfield, Viewed In Raised Position

UPPER PLAYFIELD PARTS LIST

<u>Item</u>	<u>Part Number</u>	<u>Description</u>	<u>Not Shown:</u>
1	A-16936	Kicker Bracket Assembly	
2	01-8419	Playfield Hanger Bracket	A-13204-20020 Bottom Arch Assembly
3	01-11360	Ball Guide	A-13769-20020 Playfield Screened
4	20-9250-6	Flipper & Shaft-Yellow	A-16940 Playfield Plastic Assembly
5	A-16585	Ball Guide Assembly	A-17134-2 Mtg. Bracket Clamp Assy. 1/2"
6	A-16590	Ball Guide Assembly	A-17134-3 Mtg. Bracket Clamp Assy. 3/4"
7	A-16587	Ball Guide Assembly	A-17134-4 Mtg. Bracket Clamp Assy. 1"
8	02-4825-20	Spacer 1 1/4"	A-17171 Playfield Plastic Assembly
9	02-4827-4	Spacer 1/4"	A-17185 Playfield Plastic Assembly
10	01-11356	Ball Guide	12-7127 Wire Ball Rail
11	A-16592	Ball Guide Assembly	
12	A-16790	Lamp Assembly-Left	
13	A-12258-1	Nut Plate	
	02-4826-18	Spacer 1 1/8"	
14	A-16477	Ring Assembly	
15	12-6466-5	Wire Guide 1 1/4"	
16	A-16958	Scoop Assembly	
17	A-16791	Lamp Assembly-Right	
18	A-16478	Planet Assembly	
19	A-16584	Ball Guide Assembly	
20	A-16775	Bracket Assembly	
21	A-16586	Ball Guide Assembly	
22	A-16769	Lifter Arm Assembly	
23	02-4825-40	Spacer 2 1/2"	
24	02-4825-60	Spacer 3 3/4"	
25	12-6466-14	Wire Guide 3 1/2"	
26	02-4841	Spacer 3"	
27	A-16955	Back Panel Assembly	
28	A-16589	Ball Guide Assembly	
29	01-11358	Ball Guide	
30	02-4825-44	Spacer 2 3/4"	
	02-4176-24	Spacer 1 1/2"	
31	01-11716	Deflector	
32	A-16591	Ball Guide Assembly	
33	20-9732-6	Small Flipper-Yellow	
34	01-11355	Ball Guide	
35	A-16583	Ball Guide Assembly	
36	01-10905	Bracket	
37	20-6500	Steel Ball 1 1/16"	
38	A-16588	Ball Guide Assembly	
39	A-16582	Ball Guide Assembly	
40	01-11306	Ball Guide	
41	01-3575	Strike Plate	
42	A-16593	Ball Guide Assembly	
43	01-11367	Ball Guide	
44	A-14525	Kicker Bracket Assembly	
45	01-11687	Ball Guide	
46	01-11384	Ball Guide	
47	02-4825-64	Spacer 4"	
48	02-4825-30	Spacer 1 7/8"	
49	02-4778	Spacer	

*Judge Dredd has a special hardcoat playfield and does not require a full mylar. However, mylars can be purchased through your local Bally Distributor (Part Number 03-7960-20020-1).

UPPER PLAYFIELD PARTS LOCATIONS

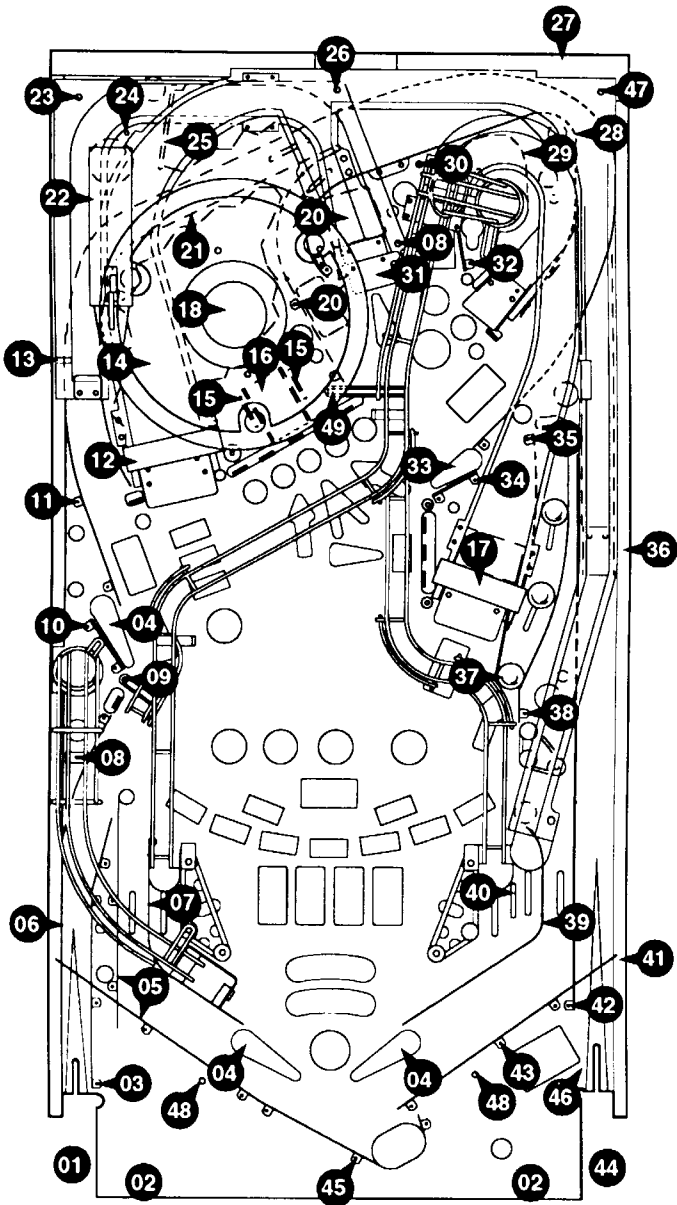

SOLENOID TABLE

Sol. No.	Function	Solenooid Type	Voltage Connections			Drive Wires	Drive Connections			Drive Wire Color	Solenooid Part Number	
			Playfield	Backbox	Cabinet		Playfield	Backbox	Cabinet		Flashlamp Type	Backbox
01	Globe Magnet	High Power	J130-1			Q82	J107-3			Vio-Brn	A-12158-1	
02	Left Popper	High Power	J130-2			Q80	J107-3			Vio-Red	AE-26-1200	
03	Right Popper	High Power	J130-4			Q78	J107-3			Vio-Orq	AE-23-800	
04	Globe Arm	High Power	J130-5			Q76	J118-2			Vio-Yel	14-7989	
05	Reset Drop Target	High Power	J130-6			Q64	J107-3			Vio-Grn	AE-24-900	
06	Globe Motor	High Power	J130-7			Q66	J118-2			Vio-Blu	14-7985	
07	Knocker	High Power	J130-8			Q68	J107-3			Vio-Blk	AE-23-800	
08	Right Shooter	High Power	J130-9			Q70	J107-3			Vio-Gry	AE-23-800	
09	Left Shooter	Low Power	J127-1			Q58	J107-2			Brn-Blk	AE-23-800	
10	Flip Drop Target	Low Power	J127-3			Q56	J107-2			Brn-Red	AE-27-1200	
11	Deviater	Low Power	J127-4			Q54	J107-2			Brn-Orq	AE-25-1000	
12	Not Used	Low Power	---			Q52	---			Brn-Yel	---	
13	Trough	Low Power	J127-6			Q50	J107-2			Brn-Grn	AE-26-1500	
14	Not Used	Low Power	---			Q48	---			Brn-Blu	---	
15	Left Slingshot	Low Power	J127-8			Q46	J107-2			Brn-Vio	AE-27-1200	
16	Right Slingshot	Low Power	J127-9			Q44	J107-2			Brn-Gry	AE-27-1200	
17	Judge Fire Flashers	Flasher	J126-1	J125-1		Q42	J107-6	J106-5		Blk-Brn	24-8802 (1)	24-8802 (1)
18	Judge Fear Flashers	Flasher	J126-2	J125-2		Q40	J107-6	J106-5		Blk-Red	24-8802 (1)	24-8802 (1)
19	Judge Death Flashers	Flasher	J126-3	J125-3		Q38	J107-6	J106-5		Blk-Orq	24-8802 (1)	24-8802 (1)
20	Judge Moris Flashers	Flasher	J126-4	J125-5		Q36	J107-6	J106-5		Blk-Yel	24-8802 (1)	24-8802 (1)
21	Pursuit Left Flashers	Flasher	J126-5	J125-6		Q28	J107-6	J106-5		Blu-Grn	24-8802 (2)	24-8802 (1)
22	Pursuit Right Flashers	Flasher	J126-6	J125-7		Q30	J107-6	J106-5		Blu-Blk	24-8802 (1)	24-8802 (1)
23	Blackout Flashers	Flasher	J126-7	J125-8		Q34	J107-6	J106-5		Blu-Vio	24-8802 (1)	24-8802 (2)
24	Cursed Earth Flashers	Flasher	J126-8	---		Q32	J107-6	---		Blu-Gry	24-8802 (2)	---
25	Lower Left Flashers	Gen. Purpose	J122-1	J124-1		Q26	J107-6	J106-5		Blu-Brn	24-8704 (2)	24-8802 (2)
26	Globe Flashers	Gen. Purpose	J122-2	J124-2		Q24	J107-6	J106-5		Blu-Red	24-8802 (1)	24-8802 (2)
27	Right Ramp Flashers	Gen. Purpose	J122-3	J124-3		Q22	J107-6	J106-5		Blu-Orq	24-8704 (2)	24-8802 (1)
28	Insert Flashers	Gen. Purpose	---	J124-5		Q20	---	J106-5		Blu-Yel	---	24-8802 (3)
General Illumination												
01	String 1	G.I.	J-120-1	J-121-1		Q18	J-120-7	J-121-6		Wht-Brn	24-8549	24-8768
02	String 2	G.I.	J-120-2	J-121-2		Q10	J-120-8	J-121-8		Wht-Orq	24-8768	24-8768
03	String 3	G.I.	J-120-3	J-121-3		Q14	J-120-9	J-121-7		Wht-Yel	24-8549	24-8768
04	String 4	G.I.	J-120-5	J-121-5		Q16	J-120-10	J-121-10		Wht-Grn	24-8768	24-8768
05	String 5	G.I.	J-121-6	---		Q12	J-120-11	---		Wht-Vio	24-8768	---
Flipper Circuits												
			Voltage Connections		Drive Transistors	Drive Connections		Drive Wire Colors		Coil Part Number	Coil Colors	
			Playfield	Power	Hold	Playfield	Power	Hold				
	Lower Left Flipper	Lwr. Lt. Power	J802-7 (Gry-Yel)		Q3	J802-9			Blu-Gry			
		Lwr. Lt. Hold	J802-7 (Gry-Yel)			J802-7						
		Lwr. Rt. Power	J802-9 (Blu-Yel)		Q4	J802-13			Blu-Vio	Org-Blu	FL-11629 BLUE	
		Lwr. Rt. Hold	J802-9 (Blu-Yel)			J802-11				Org-Grn	FL-11629 BLUE	
	Upper Left Flipper	Up. Lt. Power	J802-1 (Gry-Yel)		Q1	J802-3			Blk-Blu			
		Up. Lt. Hold	J802-1 (Gry-Yel)			J802-1				Org-Gry	FL-11629 BLUE	
		Up. Rt. Power	J802-4 (Blu-Yel)		Q2	J802-6			Blk-Yel			
		Up. Rt. Hold	J802-4 (Blu-Yel)			J802-4			Org-Vio	FL-11630 RED		

J1XX = Power Driver Board, J9XX = Electronic II Board, 24-8549 = #44 Bulb, 24-8704 = #89 Bulb, 24-8768 = #555 Bulb, 24-8802 = #906 Bulb

SOLENOID LOCATIONS

Item	Coil/Flasher Number	Assembly Number	Description
01	A-12158-1	A-16769	Globe Magnet
02	AE-26-1200	A-16580	Left Popper
03	AE-23-800	A-15769	Right Popper
04	14-7989	A-16678	Globe Arm
05	AE-24-900	A-16947	†Reset Drop Targets
06	14-7985	A-16478	†Globe Motor
07	AE-23-800	B-16086-1	*Knocker
08	AE-23-800	A-14525	Right Shooter
09	AE-23-800	A-16936	Left Shooter
10	AE-27-1200	A-16445	†Trip Drop Target
11	AE-25-1000	A-16802	†Diverter
12	Not Used
13	AE-26-1500	A-16765	Trough
14	Not Used
15	AE-27-1200	A-14369-L	Left Slingshot
16	AE-27-1200	A-14369-R	Right Slingshot
17	24-8802	A-16844	Judge Fire Flashers (2)
18	24-8802	A-16844	Judge Fear Flashers (2)
19	24-8802	A-16844	Judge Death Flashers (2)
20	24-8802	A-16844	Judge Morts Flashers (2)
21	24-8802	A-12336-1	Pursuit Left Flashers (3)
22	24-8802	A-12336-1	Pursuit Right Flashers (3)
23	24-8802	A-16929	Blackout Flashers (3)
24	24-8802	†A-16891	Cursed Earth Flashers (2)
25	24-8704	A-8798	Lower Left Flashers (4)
	24-8802
26	24-8802	A-16475	†Globe Flashers (3)
27	24-8704	A-8798	Right Ramp Flashers (3)
	24-8802
28	24-8802	...	*Insert Flashers (3)

General Illumination Circuits

*01	String 1	24-6549, 24-8768	GI String 1
*02	String 2	24-8768	GI String 2
*03	String 3	24-6549, 24-8768	GI String 3
*04	String 4	24-8768	GI String 4
*05	String 5	24-8768	GI String 5

Flipper Coils

Coil	Assembly	Description
*FL-11629 (Blue)	A-15205-L-2	Lower Left Flipper
*FL-11629 (Blue)	A-15205-R-2	Lower Right Flipper
*FL-11629 (Blue)	A-16976-L	Upper Left Flipper
*FL-11630 (Red)	A-15205-R	Upper Right Flipper

*Not Shown
†Located Under Playfield

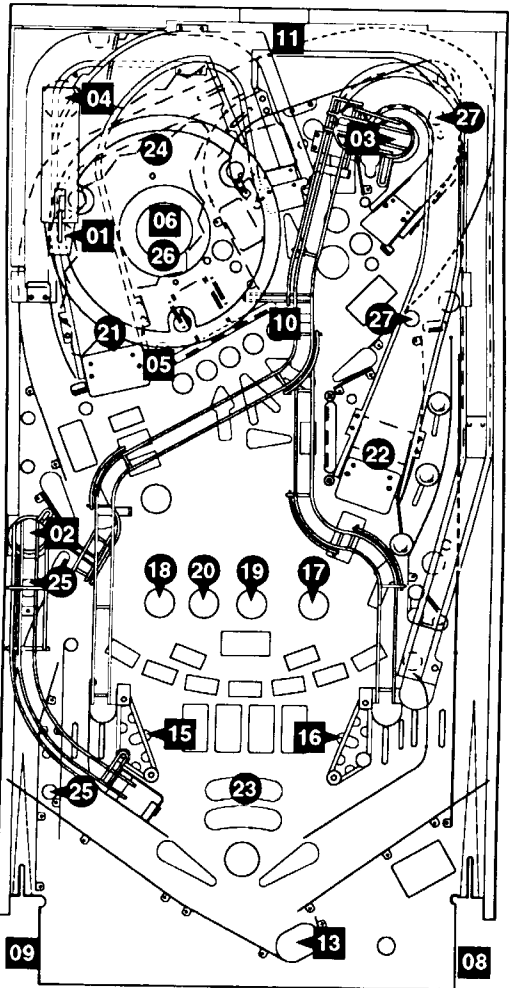

■ Square indicates coil, P.C.B. or Magnet
● Circle indicates flasher

LAMP MATRIX

Yellow (B+)  Red

Column Row	1 Yellow-Brown J133-1 Q98	2 Yellow-Red J137-2 Q97	3 Yellow-Orange J137-3 Q96	4 Yellow-Black J137-4 Q95	5 Yellow-Green J137-5 Q94	6 Yellow-Blue J137-6 Q93	7 Yellow-Violet J138-7 Q92	8 Yellow-Gray J138-9 Q91
1 Red-Brown J133-1 Q90	Perp 1 (White) 11	Perp 4 (White) 21	Perp 3 (White) 31	Crime Level 4 (White) 41	Stakeout 51	Right Extra Ball 61	Drop Target 'J' 71	Award Stakeout 81
2 Red-Black J133-2 Q89	Perp 1 (Red) 12	Perp 4 (Red) 22	Perp 3 (Red) 32	Crime Level 3 (Red) 42	Safe-cracker 52	Right Start Feature 62	Drop Target 'U' 72	Blackout Jackpot 82
3 Red-Orange J133-4 Q88	Perp 1 (Yellow) 13	Perp 4 (Yellow) 23	Perp 3 (Yellow) 33	Crime Level 2 (Yellow) 43	Pursuit 53	Tank Center 63	Drop Target 'D' 73	Drain Shield 83
4 Red-Yellow J133-5 Q87	Perp 1 (Green) 14	Perp 4 (Green) 24	Perp 3 (Green) 34	Crime Level 1 (Green) 44	Ultimate Challenge 54	Award Sniper 64	Drop Target 'G' 74	Judge Again 84
5 Red-Green J133-6 Q86	Perp 2 (White) 15	Perp 5 (White) 25	Lock 1 35	Meltdown 45	Manhunt 55	Air Raid 65	Drop Target 'E' 75	Advance Crime Level 85
6 Red-Blue J133-7 Q85	Perp 2 (Red) 16	Perp 5 (Red) 26	Lock 2 36	Impersonator 46	Blackout 56	Left Center Feature 66	Award Safe-cracker 76	Tank Right 86
7 Red-Violet J133-8 Q84	Perp 2 (Yellow) 17	Perp 5 (Yellow) 27	Lock 3 37	Battle Tank 47	Sniper 57	Tank Left 67	Multi-ball Jackpot 77	Super Game 87
8 Red-Gray J133-9 Q83	Perp 2 (Green) 18	Perp 5 (Green) 28	Buy-In 38	Stop Meltdown 48	Pick A Prize 58	Mystery 68	Award Bad Impersonator 78	Start Button 88

J1XX = Power Driver Board

LAMP LOCATIONS

Item No.	Bulb No.	Lamp Assy. No.	Description
11	24-8768	A-16843	Perp 1 (White)
12	24-8768	A-16843	Perp 1 (Red)
13	24-8768	A-16843	Perp 1 (Yellow)
14	24-8768	A-16843	Perp 1 (Green)
15	24-8768	A-16843	Perp 2 (White)
16	24-8768	A-16843	Perp 2 (Red)
17	24-8768	A-16843	Perp 2 (Yellow)
18	24-8768	A-16843	Perp 2 (Green)
21	24-8768	A-16843	Perp 4 (White)
22	24-8768	A-16843	Perp 4 (Red)
23	24-8768	A-16843	Perp 4 (Yellow)
24	24-8768	A-16843	Perp 4 (Green)
25	24-8768	A-16843	Perp 5 (White)
26	24-8768	A-16843	Perp 5 (Red)
27	24-8768	A-16843	Perp 5 (Yellow)
28	24-8768	A-16843	Perp 5 (Green)
31	24-8768	A-16843	Perp 3 (White)
32	24-8768	A-16843	Perp 3 (Red)
33	24-8768	A-16843	Perp 3 (Yellow)
34	24-8768	A-16843	Perp 3 (Green)
35	24-6549	A-11754	Lock 1
36	24-6549	A-11271	Lock 2
37	24-6549	A-11754	Lock 3
38	---	20-9663-13	Buy-In
41	24-8768	A-16839	Crime Level 4 (White)
42	24-8768	A-16839	Crime Level 3 (Red)
43	24-8768	A-16839	Crime Level 2 (Yellow)
44	24-8768	A-16839	Crime Level 1 (Green)
45	24-8768	A-16839	Meltdown
46	24-8768	A-16839	Impersonator
47	24-8768	A-16839	Battle Tank
48	24-8768	B-12224	Stop Meltdown
51	24-8768	A-16839	Stakeout
52	24-8768	A-16839	Safecracker
53	24-8768	A-16839	Pursuit
54	24-8768	A-16839	Ultimate Challenge
55	24-8768	A-16839	Manhunt
56	24-8768	A-16839	Blackout
57	24-8768	A-16839	Sniper
58	24-6549	A-8882	Pick A Prize
61	24-8768	A-16841	Extra Ball (2)
62	24-8768	A-16841	Right Start Feature
63	24-8768	A-16841	Tank Center
64	24-8768	A-16841	Award Sniper
65	24-8768	A-16841	Air Raid
66	24-6549	A-11754	Left Center Feature
67	24-6549	A-11754	Tank Left
68	24-6549	A-11271	Mystery
71	24-8768	A-16840	Drop Target "J"
72	24-8768	A-16840	Drop Target "U"
73	24-8768	A-16840	Drop Target "D"
74	24-8768	A-16840	Drop Target "G"
75	24-8768	A-16840	Drop Target "E"
76	24-8768	A-16840	Award Safecracker
77	24-8768	A-16840	Multi-ball Jackpot
78	24-8768	A-16840	Award Bad Impersonator
81	24-6549	A-8882	Award Stakeout
82	24-6549	A-11754	Blackout Jackpot
83	24-8768	A-16929 (2)	Drain Shield
84	24-8768	A-16929	Judge Agan
85	24-8768	A-16340	Advance Crime Level
86	24-8768	A-16340	Tank Right
87	---	20-9663-10	Super Game
88	---	20-9663-1	Start Button

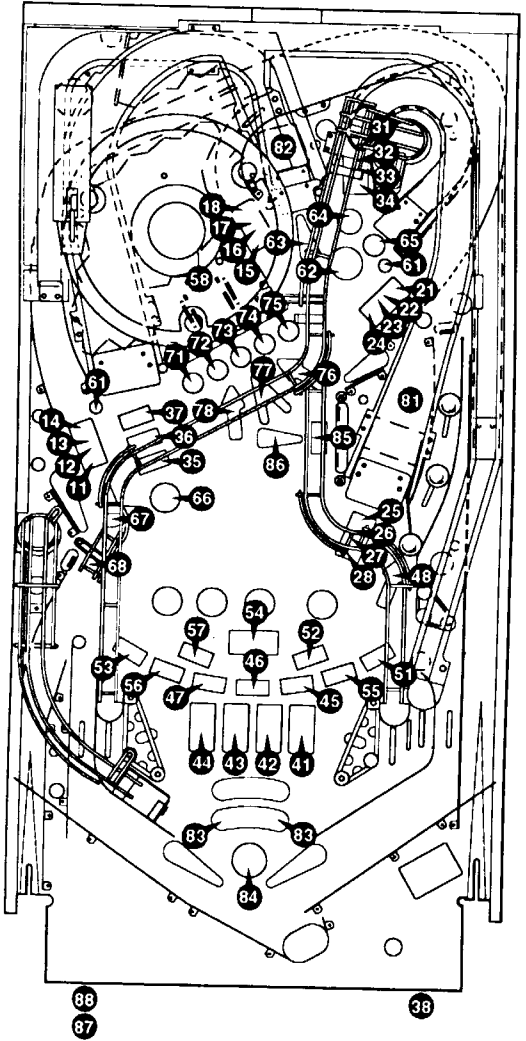

Light bulb covers:
 03-8063-2 Green
 03-8063-4 Red
 03-8063-5 White
 03-8063-6 Yellow

* Not Shown

† Located Under Playfield

24-8768 = #555 Bulb
 24-6549 = #44 Bulb

SWITCH MATRIX

Dedicated Grounded Switches	Column Row	White						Green		Flipper Grounded Switches
		1 Green-Brown J207-1 U20-18	2 Green-Red J207-2 U20-17	3 Green-Orange J207-3 U20-16	4 Green-Yellow J207-4 U20-15	5 Green-Black J207-5 U20-14	6 Green-Blue J207-6 U20-13	7 Green-Violet J207-7 U20-12	8 Green-Gray J207-9 U20-11	
Orange-Brown J206-1 Left Coin Chute D1	1 White-Brown J209-1 U18-11	Left Fire Button	Siam Tilt	Buy In (Extra Ball)	Right Ball Shooter	Left Sling (2)	Globe Position #1	Magnet Over Ring	Trough 1	Black-Green J906-1 Right Flipper End of Stroke F1
Orange-Red J206-2 Center Coin Chute D2	2 White-Red J209-2 U18-9	Right Fire Button	Front Door Closed	Not Used	Right Outlane	Right Sling (2)	Crane Exit	Top Right Opto	Trough 2	Blue-Violet J905-1 Right Flipper Opto F2
Orange-Black J206-3 Right Coin Chute D3	3 White-Orange J209-3 U18-5	Credit (Start)	Ticket Dispenser	Left Rollover	Outside Right Return	Captive Ball 2	Left Ramp To Lock	Left Popper	Trough 3	Black-Blue J906-3 Left Flipper End of Stroke F3
Orange-Yellow J206-4 4th Coin Chute D4	4 White-Yellow J209-4 U18-7	Plumb Bob Tilt	Always Closed	Inside Right Return	Super Game	Drop Target "J"	Left Ramp Exit	Right Popper	Trough 4	Blue-Gray J905-2 Left Flipper Opto F4
Orange-Green J206-5 Normal Function Credits Escapes D5	5 White-Green J209-5 U19-11	Left Shoot Lane	Top Right Post	Top Center Rollover	Not Used	Drop Target "U"	Not Used	Top Ramp Exit	Trough 5	Black-Violet J906-4 Upper Right Flipper End of Stroke F5
Orange-Blue J206-6 Normal Function Volume Down D6	6 White-Blue J209-7 U19-9	Left Outlane	Captive Ball 1	Left Score Post	Not Used	Drop Target "D"	Center Ramp Exit	Right Ramp Exit	Trough 6	Black-Yellow J906-5 Upper Right Flipper Opto F6
Orange-Violet J206-7 Normal Function	7 White-Violet J209-8 U19-5	Left Return Lane	Mystery	Subway Enter 1	Not Used	Drop Target "G"	Left Ramp Enter	Globe Position #2	Top Trough	Black-Gray J906-6 Upper Left Flipper End of Stroke F7
Orange-Gray J206-8 Normal Function Begin Test Enter D8	8 White-Gray J209-9 U19-7	3-Bank Targets	Not Used	Subway Enter 2	Not Used	Drop Target "E"	Captive Ball 3	Not Used	Not Used	Black-Blue J905-5 Upper Left Flipper Opto F8

J20X = CPU Board, J90X = Fliptron II Board = Opto, Typically Closed

SWITCH LOCATIONS

Item	Switch Part #	Where Used	Item	Switch Part #	Where Used
F1	SW-1A-194	*Lower Right Flipper EOS	25	A-16910-15	Top Right Post
F2	A-18384-1	*Lower Right Flipper Cabinet	26	5647-12693-19	Captive Ball 1
F3	SW-1A-194	*Lower Left Flipper EOS	27	A-14227-15	Mystery
F4	A-15894	*Lower Left Flipper Cabinet	28	---	Not Used
F5	SW-1A-194	*Upper Right Flipper EOS	31	20-9663-9	Buy-In (Extra Ball)
F6	A-16384-1	*Upper Right Flipper Cabinet	32	---	Not Used
F7	SW-1A-194	*Upper Left Flipper EOS	33	5647-12693-19	Left Rollover
F8	A-15894	*Upper Left Flipper Cabinet	34	5647-12693-19	Inside Right Return
			35	5647-12693-19	Top Center Rollover
11	20-9846-1	Left Fire Button	36	A-16910-15	Left Score Target
12	20-9846-1	Right Fire Button	37	5647-12693-13	*Subway Enter 1
13	20-9663-1	Credit (Start)	38	5647-12693-13	*Subway Enter 2
14	A-15361	*Plumb Bob Tilt	41	5647-12693-19	Right Ball Shooter
15	5647-12693-19	Left Shoot Lane	42	5647-12693-19	Right Outlane
16	5647-12693-19	Left Outlane	43	5647-12693-19	Outside Right Return
17	5647-12693-19	Left Return Lane	44	20-9663-13	Super Game
18	A-14227-15	3-bank Targets	45	---	Not Used
21	SW-1A-117	*Siam Tilt	46	---	Not Used
22	5643-09288-00	*Front Door Closed	47	---	Not Used
23	---	*Ticket Dispenser	48	---	Not Used
24	5643-09288-00	*Closed			

SWITCH LOCATIONS (CONTINUED)

Item	Switch Part #	Where Used
51	SW-1A-114	Left Sling (Kicker)
	SW-1A-120	(Score)
52	SW-1A-114	Right Sling (Kicker)
	SW-1A-120	(Score)
53	5647-12693-19	Captive Ball 2
54	A-16486	Drop Target 'J'
55	A-16486	Drop Target 'U'
56	A-16486	Drop Target 'D'
57	A-16486	Drop Target 'G'
58	A-16486	Drop Target 'E'
61	A-16598	*Globe Position #1
62	A-14231 (LED)	Left Ramp Enter
	A-14232 (Trans.)	
63	A-14231 (LED)	Left Ramp To Lock
	A-14232 (Trans.)	
64	A-14231 (LED)	Left Ramp Exit
	A-14232 (Trans.)	
65	---	Not Used
66	A-14231 (LED)	Center Ramp Exit
	A-14232 (Trans.)	
67	A-14231 (LED)	Left Ramp Enter
	A-14232 (Trans.)	
68	A-14227-15	Captive Ball 3
71	A-14231 (LED)	†Magnet Over Ring
	A-14232 (Trans.)	
72	A-14231 (LED)	Top Right Opto
	A-14232 (Trans.)	
73	A-14231 (LED)	Left Popper
	A-14232 (Trans.)	
74	A-14231 (LED)	Right Popper
	A-14232 (Trans.)	
75	A-14231 (LED)	Top Ramp Exit
	A-14232 (Trans.)	
76	A-14231 (LED)	Right Ramp Exit
	A-14232 (Trans.)	
77	A-16598	*Globe Position #2
78	---	Not Used
81	A-16926 (Trans.)	Trough 1
	A-16927 (LED)	
82	A-16926 (Trans.)	Trough 2
	A-16927 (LED)	
83	A-16926 (Trans.)	Trough 3
	A-16927 (LED)	
84	A-16926 (Trans.)	Trough 4
	A-16927 (LED)	
85	A-16926 (Trans.)	Trough 5
	A-16927 (LED)	
86	A-16926 (Trans.)	Trough 6
	A-16927 (LED)	
87	A-16926 (Trans.)	Top Trough
	A-16927 (LED)	
88	---	Not Used

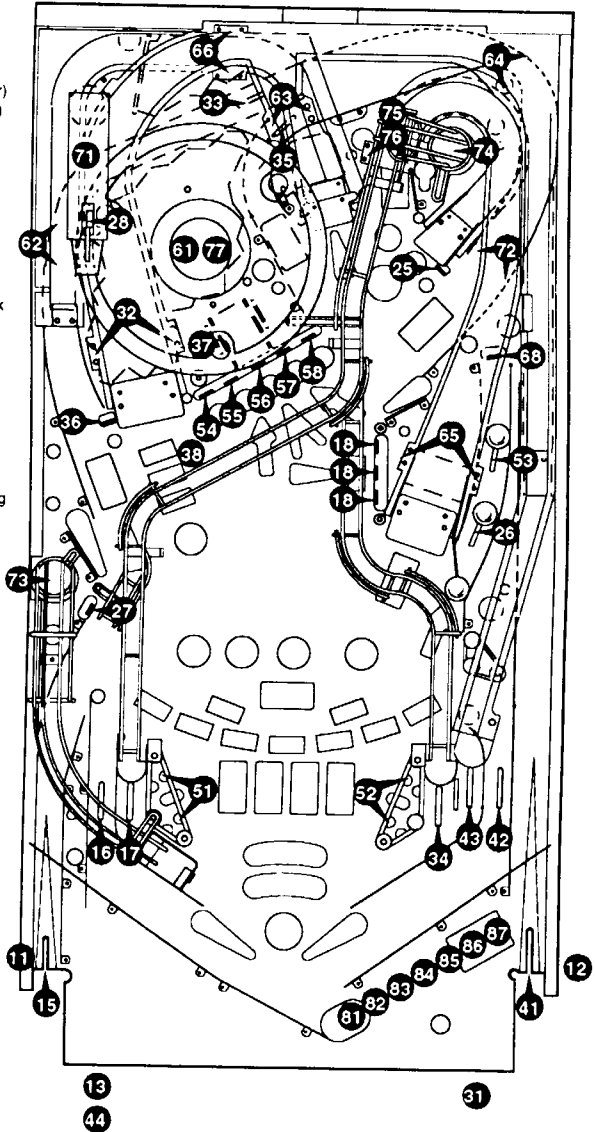

* Not Shown

† Located Under Playfield

MENU SYSTEM OPERATION

The Main Menu allows you to choose from several categories, which in turn lead to other menus. To access the Main Menu, open the coin door and press the Begin Test button, then press the Enter button. Press the Up or Down buttons to cycle through the Main Menu. Press the Enter button to access a menu. Press the Escape button to return to the Main Menu. Press the Start button for HELP at any time.

Main Menu

B. Bookkeeping Menu	
	B.1 Main Audits
	B.2 Earnings Audits
	B.3 Standard Audits
	B.4 Feature Audits
	B.5 Histograms
	B.6 Time-Stamps
P. Printouts Menu	
	P.1 Earnings Data
	P.2 Main Audits
	P.3 Standard Audits
	P.4 Feature Audits
	P.5 Score Histograms
	P.6 Game Time Histograms
	P.7 Time-Stamps
	P.8 All Data
T. Test Menu	
	T.1 Switch Edges
	T.2 Switch Levels
	T.3 Single Switches
	T.4 Solenoid Test
	T.5 Flasher Test
	T.6 General Illumination
	T.7 Sound & Music Test
	T.8 Single Lamps
	T.9 All Lamps
	T.10 Lamp & Flasher Test
	T.11 Display Test
	T.12 Flipper Test
	T.13 Ordered Lamp Test
	T.14 Planet Test
	T.15 Planet Arm Test
	T.16 Unload Globe Test
U. Utilities Menu	
	U.1 Clear Audits
	U.2 Clear Coins
	U.3 Reset H.S.T.D.
	U.4 Set Time & Date
	U.5 Custom Message
	U.6 Set Game I.D.
	U.7 Factory Adjustments
	U.8 Factory Resets
	U.9 Presets
	U.10 Clear Credits
	U.11 Auto Burn-In
A. Adjustments Menu	
	A.1 Standard Adjustments
	A.2 Feature Adjustments
	A.3 Pricing Adjustments
	A.4 H.S.T.D. Adjustments
	A.5 Printer Adjustments

Press Escape

To move out of a menu selection.

Press Enter

To get into a menu selection.

Press Up

Increases sequence; Example A.1, A.2, A.3, A.4.

Press Down

Decreases Sequence; Example A.4, A.3, A.2, A.1.

Use Up and Down to cycle through the selections in a menu.

Use Escape and Enter to move into and out of the selected menu

FUSE LIST

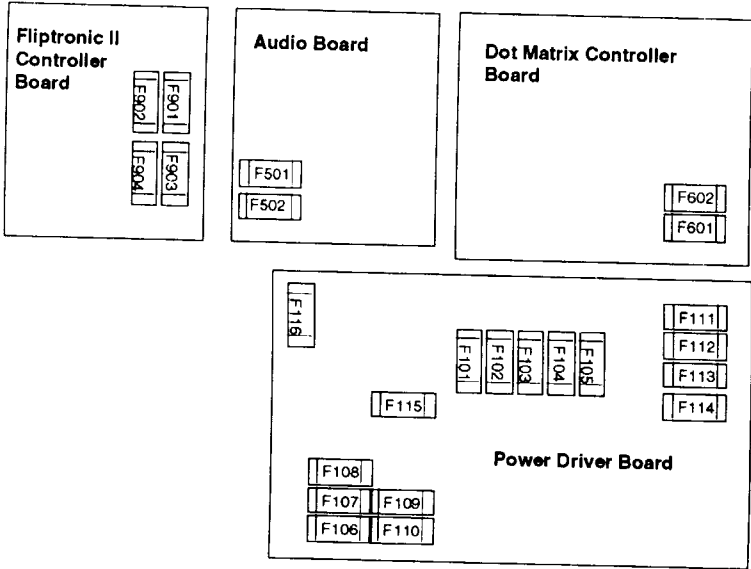

Audio Board

- F501 -25V Circuit 3A, 250V, S.B.
- F502 +25V Circuit 3A, 250V, S.B.

Dot Matrix Controller Board

- F601 +62V Circuit 3/8A, 250V, F.B.
- F602 -113V and -125V Circuits 3/8A, 250V, F.B.

Power Driver Board

- F101 Left Flipper 3A, 250V, S.B. (Not Used)
- F102 Right Flipper 3A, 250V, S.B. (Not Used)
- F103 Solenoid #25-#28 3A, 250V, S.B.
- F104 Solenoid #9-#16 3A, 250V, S.B.
- F105 Solenoid #1-#8 3A, 250V, S.B.
- F106 G.I. #5 Wht-Vio 5A, 250V, S.B.
- F107 G.I. #4 Wht-Grn 5A, 250V, S.B.
- F108 G.I. #3 Wht-Yel 5A, 250V, S.B.
- F109 G.I. #2 Wht-Org 5A, 250V, S.B.
- F110 G.I. #1 Wht-Brn 5A, 250V, S.B.
- F111 Flasher Secondary 5A, 250V, S.B.
- F112 Solenoid Secondary 7A, 250V, S.B.
- F113 +5V Logic 5A, 250V, S.B.
- F114 +18V Lamp Matrix 8A, 32V, N.B.
- F115 +12V Switch Matrix 3/4A, 250V, F.B.
- F116 +12V Secondary 3A, 250V, S.B.

Fliptronic II Controller Board

- F901 Upper Right Flipper 3A, 250V, S.B.
- F902 Upper Left Flipper 3A, 250V, S.B.
- F903 Lower Right Flipper 3A, 250V, S.B.
- F904 Lower Left Flipper 3A, 250V, S.B.

Line Filter

- Domestic Game 8A
- Foreign Game 5A, S.B.

WARNINGS & NOTICES

WARNING

FOR SAFETY AND RELIABILITY, substitute parts and equipment modifications are not recommended. Use of Non-BALLY parts or modifications of game circuitry, may adversely affect game play, or may cause injuries.

SUBSTITUTE PART OR EQUIPMENT MODIFICATIONS may void FCC Type Acceptance.

BECAUSE THIS GAME IS PROTECTED by Federal copyright, trademark, and patent laws, unauthorized game conversions may be illegal under Federal law.

THIS 'CONVERSION' PRINCIPLE ALSO APPLIES to unauthorized facsimiles of BALLY equipment, logos, designs, publications, assemblies and games (or game feature not deemed to be public domain), whether manufactured with BALLY components or not.

Notice

MIDWAY® is a registered trademark of Midway Manufacturing Company. JUDGE DREDD™ and BALLY® are trademarks used by Midway with permission. WILLIAMS, Lane-change and Multi-ball are trademarks of WILLIAMS Electronics Games, Inc. Entire contents of this manual ©1993 MIDWAY MANUFACTURING COMPANY, manufacturers of BALLY Amusement Games. All rights reserved.

WARNING

NOTE: This equipment has been tested and found to comply with the limits for a Class A digital device, pursuant to Part 15 of the FCC Rules. These limits are designed to provide reasonable protection against harmful interference when the equipment is operated in a commercial environment. This equipment generated, uses, and can radiate radio frequency energy and if not installed and used in accordance with the instruction manual, may cause harmful interference to radio communications. Operation of this equipment in a residential area is likely to cause harmful interference in which case the user will be required to correct the interference at his own expense.

RF Interference Notice

CABLE HARNESS PLACEMENTS and ground strap routing on this game have been designed to keep RF radiation and conduction within levels accepted by the FCC Rules.

TO MAINTAIN THESE LEVELS, reposition harnesses and reconnect ground straps to their original placements, if they become disconnected during maintenance.

FCC STICKER. Check the back of your game to verify that an FCC-certification sticker was attached to your game at the factory. All Games that leave the BALLY plant have been tested and found to comply with FCC Rules. Because the sticker is proof of this fact, legal repercussions to the owner and distributor may result, if the sticker is missing. If you receive a game, manufactured after December 1982, that has no FCC sticker, call BALLY for advice or write us a note on your Game Registration Card. Be sure that the card bears your game's serial number.

FOR SERVICE...
CALL your authorized
BALLY Distributor

MIDWAY Manufacturing Company
3401 N. California
Chicago, IL 60618

©1993 Midway Manufacturing Company

©1993 Egmont H. Peterson Fond, Gutenberghus.
Judge Dredd™, the character representation and
all other elements are trademarks used under license from
Egmont H. Peterson Fond, Gutenberghus.
Licensed by Copyright Promotions Limited and Surge Licensing, Inc.

**CAUTION: Transport this game ONLY
with hinged backbox DOWN!**